

INSTALLATION & MAINTENANCE GUIDE

ROLLER-, ATTACHMENT- AND CONVEYOR CHAIN



LEADING PRODUCTS AND EXCELLENT SERVICE

At TSUBAKI we know that customers want the best. We are also aware that each and every one of our customers has unique requirements. Therefore, we take pride in our ability to deliver an extensive product line-up that satisfies these high expectations. We believe that in coming years there will be an increase in demand for quality in products as well as in services. With an eye on these future trends, we are committed to take on the challenge of technical innovation.

Key products such as BS/DIN, ANSI drive chains, small pitch attachment and large pitch conveyor chains for industrial applications through to high efficiency timing chains and tensioners for automotive engine primary drives ensure Tsubaki stays at the forefront of engineering excellence. Specific products such as pioneering Lambda lube free chain, N.E.P. chain for corrosion protection and specialist chains such as engineering plastic help Tsubaki provide chain solutions to many of the world's most demanding industries and applications. The same can be said for Tsubaki TEM products such as cam clutches, couplings, overload protection devices, reducers & linear actuators.

Tsubaki care does not stop at the design & manufacture stage or even at the receipt of the product by the final customer. For products to fulfil their planned lifecycle Tsubaki sees the initial installation, ongoing customer maintenance & aftercare support programs as one of the major support functions of a global manufacturer, with the ability to supply the services at a local level when the customer needs it. That is why Tsubaki supports its customers and products with helpful advice and information through the sales, field engineering and technical support departments. With site surveys, inspection services and a host of support literature to ensure customers can successfully install, maintain & provide an aftercare service for the lifetime of their product.



Tsubakimoto Europe B.V. serves the Pan-European market, Africa and the Middle East. Our headquarters are located in Dordrecht, the Netherlands, serving Power Transmission customers. From the subsidiary office in Nottingham, Tsubaki UK serves the United Kingdom, Ireland and Iceland and from the office in Gilching, Germany customers in Germany, Austria and Switzerland are served. The TSUBAKI Group includes 46 production locations and 63 group companies worldwide. Our production and sales networks are now more developed than ever.

TABLE OF CONTENTS

Roller Chain

1	Introduction to TSUBAKI Roller Chain	6
2	Ordering TSUBAKI Roller Chain	11
3	Cutting TSUBAKI Roller Chain	15
4	Connecting TSUBAKI Roller Chain	16
5	Sprockets	17
6	Installing TSUBAKI Roller Chain	18
7	Lubrication	22
8	Chain Test Run	25
9	Roller Chain Inspection	26
10	Special Environments	30
11	Roller Chain Troubleshooting and Problem-Solving	31

Attachment Chain

1	Introduction to TSUBAKI Attachment Chain	36
2	Ordering TSUBAKI Attachment Chain	44
3	Cutting TSUBAKI Attachment Chain	48
4	Connecting TSUBAKI Attachment Chain	52
5	Installing TSUBAKI Attachment Chain	54
6	Lubrication	55
7	Tension Adjustment	56
8	Chain Test Run	57
9	Attachment Chain Inspection	57
10	Usage Limits	58
11	Other Precautions	59
12	Attachment Chain Troubleshooting and Problem-Solving	60

TABLE OF CONTENTS

Conveyer Chain

1	Introduction to TSUBAKI Conveyer Chain	65
2	Ordering TSUBAKI Conveyer Chain	68
3	Cutting TSUBAKI Conveyer Chain	68
4	Connecting TSUBAKI Conveyer Chain	68
5	Installing TSUBAKI Conveyer Chain	69
6	Lubrication	70
7	Tension Adjustment	71
8	Chain Test Run	71
9	Life of TSUBAKI Conveyer Chain and Sprocket	72
10	Other Precautions	73
11	Conveyer Chain Troubleshooting and Problem-Solving	74

Appendix	78
---------------------------	----

Corrosion resistance guide	80
---	----

General terms and conditions	82
---	----

1. INTRODUCTION TO TSUBAKI ROLLER CHAIN

1.1 Glossary

1. Minimum Tensile Strength as per ISO Standardisation

This is the Minimum Tensile Strength determined by ISO. If a roller chain fails a tensile load below this value, it does not surpass the standards.

2. Minimum Tensile Strength as per TSUBAKI Standardisation

This is a minimum value determined by statistical processes at TSUBAKI. If a roller chain fractures at a tensile load below this value, it does not surpass TSUBAKI standards. TSUBAKI standards are higher than ISO standards.

3. Average Tensile Strength as per TSUBAKI Standardisation

This is a fracture load reading obtained after a long period of actual tensile strength testing of a large number of chain strands. Of course, when any given strand of roller chain fractures, this value may be higher or lower, so it does not represent a guaranteed value.

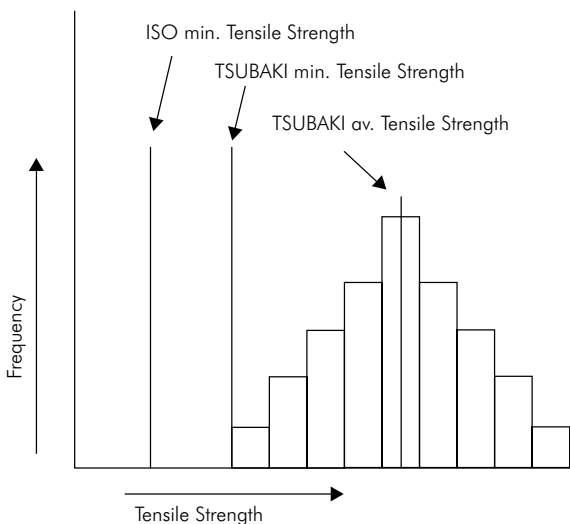

Relationship between the three tensile strengths mentioned above

4. Tensile Strength Testing Method

As shown in below figure, a roller chain with minimum of five links is fixed at both ends by clevises and tensioned until fracture occurs. The type of fracture can be used to determine the cause of the breakage of the chain.

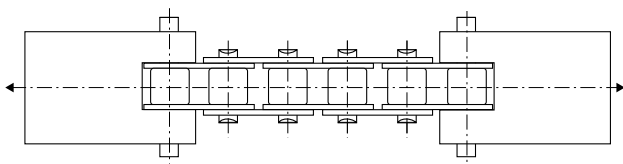

Tensile Strength test

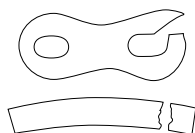

Shape of fracture

5. Maximum Allowable Load

The Maximum Allowable Load (M.A.L.) of a roller chain (excluding Stainless Steel Chain and Engineering Plastic Chain) is the value derived from the lowest fatigue limit. When a load lower than this value is repetitively applied to the roller chain, fatigue failure will never occur.

The TSUBAKI M.A.L. is determined after 10 million repetitive loads instead of 3 million repetitive loads which is the European Standard.

The Maximum Allowable Load of Stainless Steel Chain and Engineering Plastic Chain is determined by the surface pressure between the pins and bushes.

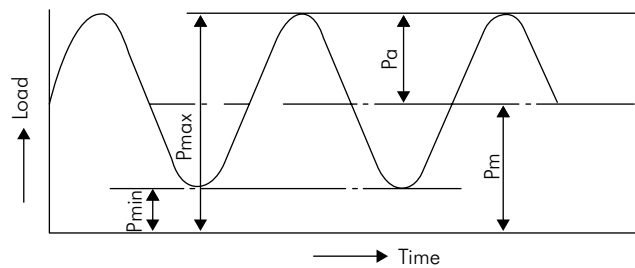

Summary chart for repetitive loads

6. Ring Coining Process

For easy assembling the pin and link plate of a connecting link are slip fit. In general, this type of connecting link has a 20% lower fatigue strength than the chain itself. However, TSUBAKI developed a special process to eliminate that loss of fatigue strength and still satisfy the customers demand for easy assembling: the Ring Coining process. By applying the Ring Coining process, TSUBAKI generates a cold deformation around the pin hole of the connecting link plate. This results in residual stress around the pin hole and thereby adds strength. By using this process, transmission capacity is increased back to 100%.

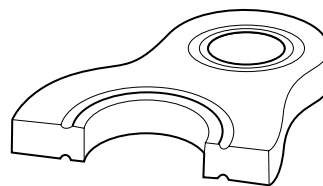

Ring Coin

For severe conditions, TSUBAKI has developed the Heavy Duty Chain series. These chains are standard equipped with press fit connecting links. The installation is more difficult than in case of standard connecting links.

1. INTRODUCTION TO TSUBAKI ROLLER CHAIN

7. Ball Drifting Process

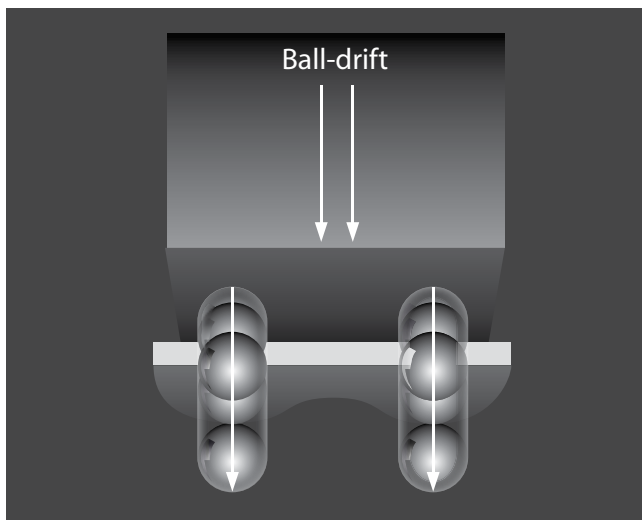

Ball Drifting

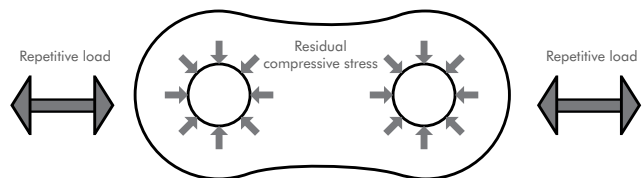

Residual Compressive Stress

Ball drifting is the process of pressing a hardened steel ball through a hole in an already hardened steel plate. The goal of this process is to create local plastic deformation and effectively add compressive stress to the walls of the hole. Besides this, the process generates precisely controlled holes for an optimum press fit. Together, this leads to significantly improved fatigue life (up to 30%).

8. Shot Peening Process

Shot peening is a process used to produce a compressive residual stress layer and modify mechanical properties of metals. It means impacting a surface with shot (round metallic or ceramic particles) with force sufficient to create plastic deformation.

At TSUBAKI, all basic chain parts (except pins and bushes) are shot peened.

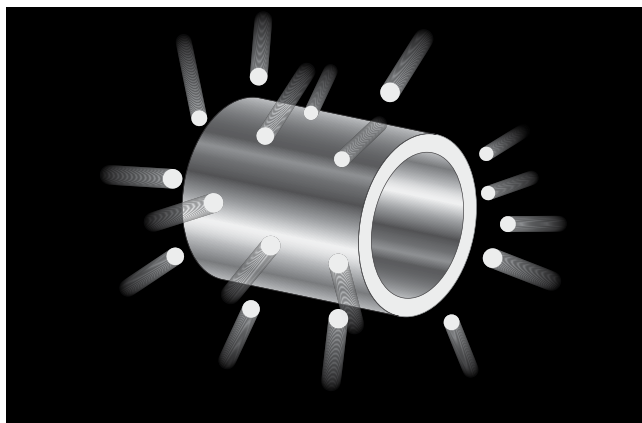

Shot Peening

Shot Peening increases resistance to:

- fatigue failure
- corrosion fatigue
- hydrogen assisted cracking
- cavitation erosion
- stress corrosion cracking
- galling
- fretting

9. Pre-Loading Process

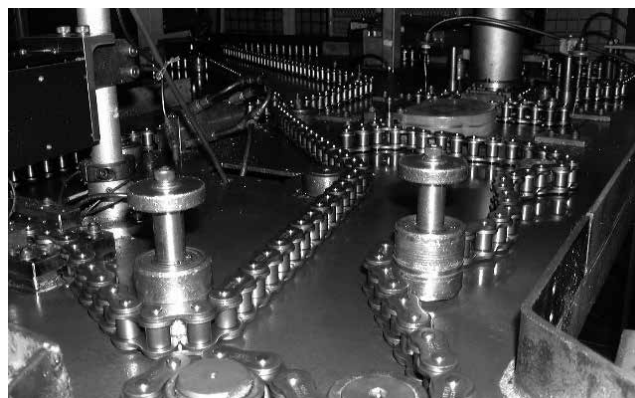

Pre-Loading

After the assembly of a chain, TSUBAKI always applies an initial load, which is called a pre-load. The pre-load force approximates the recommended Maximum Allowable Load and is applied to seat the various chain components such as pins, bushes and link plates. The benefit of pre-loading is that it minimizes the initial elongation. Minimization of this initial elongation increases the chains service life therefore pre-loading is very important.

1. INTRODUCTION TO TSUBAKI ROLLER CHAIN

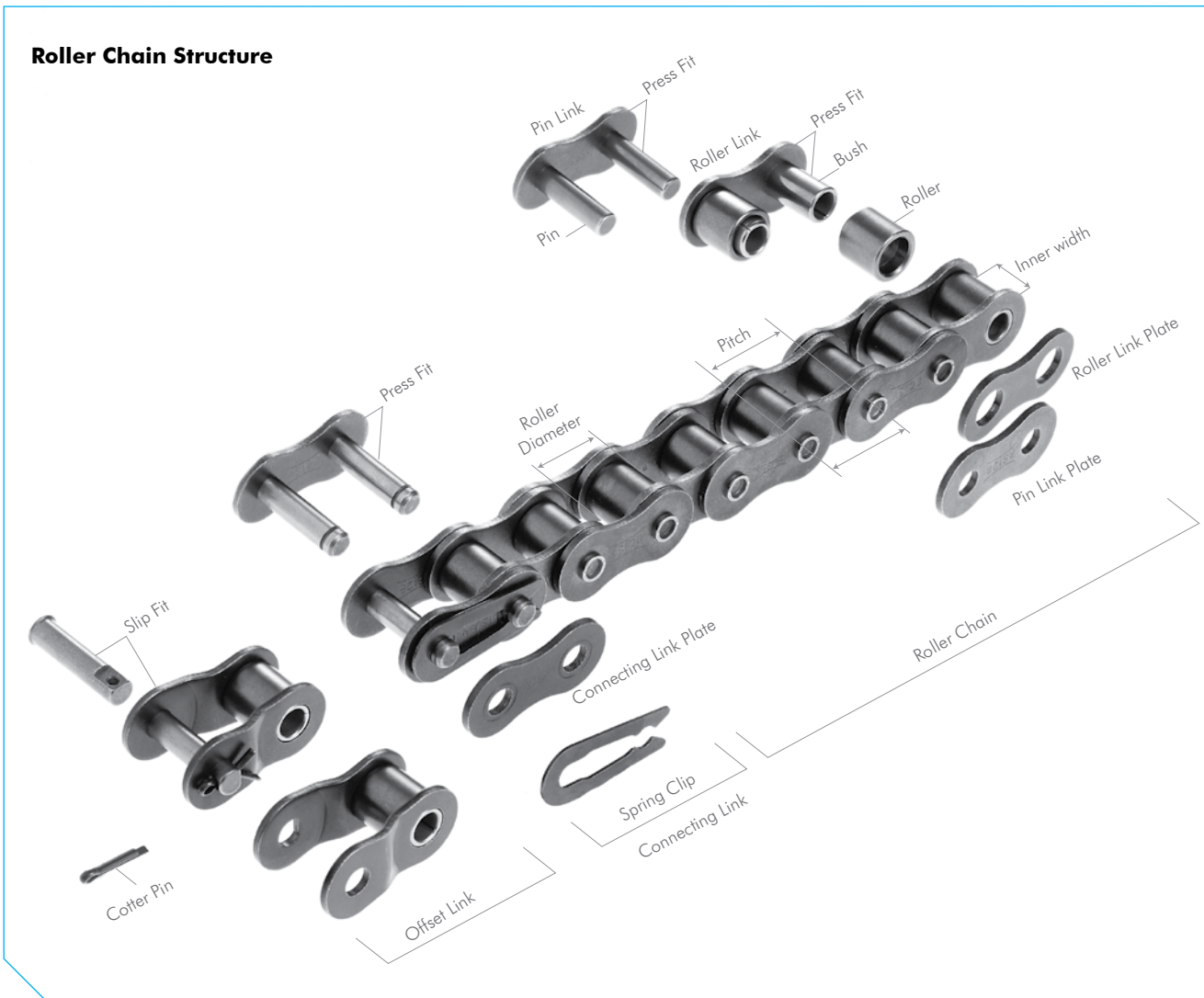

1.2 Roller Chain Structure

1. Three Basic Dimensions

Pitch, Roller Diameter and Inner Width are known as the “Three Basic Dimensions of Roller Chain.” When these three dimensions are identical, roller chains and sprockets are dimensionally compatible.

2. Basic Parts Link Plate

The plate is the component that bears the tension placed on the chain. Usually this is a repeated loading, sometimes accompanied by shock. Therefore, the plate must not only have great static tensile strength, it must also hold up to the dynamic forces of load and shock.

Pin

The pin is subject to shearing and bending forces transmitted by the plate. At the same time, it forms a load-bearing part (together with the bush) when the chain flexes during sprocket engagement. Therefore, the pin needs high tensile and shear strength, resistance to bending, and must also have sufficient endurance against shock and wear.

Bush

The bush is subject to complex forces from all parts, especially from the repetition of shock loads when the chain engages the sprocket. Therefore, the bush needs extremely high shock resistance. In addition, the bush forms a load-bearing part together with the pin and as such requires great wear resistance.

Roller

The roller is subject to impact load as it mates with the sprocket teeth during engagement of the chain with the sprocket. After engagement, the roller changes its point of contact and balance. It is held between the sprocket teeth and bush, and moves on the tooth face while receiving a compression load. Therefore, it must be resistant to wear and still have strength against shock, fatigue and compression. (RS25 and RS35 are bush chains and do not have rollers).

Roller Link

Two bushes are press fit into two roller link plates and rollers are inserted to allow rotation around the outside of the bushes during operation. This is the same for single and for multi strand chains.

1. INTRODUCTION TO TSUBAKI ROLLER CHAIN

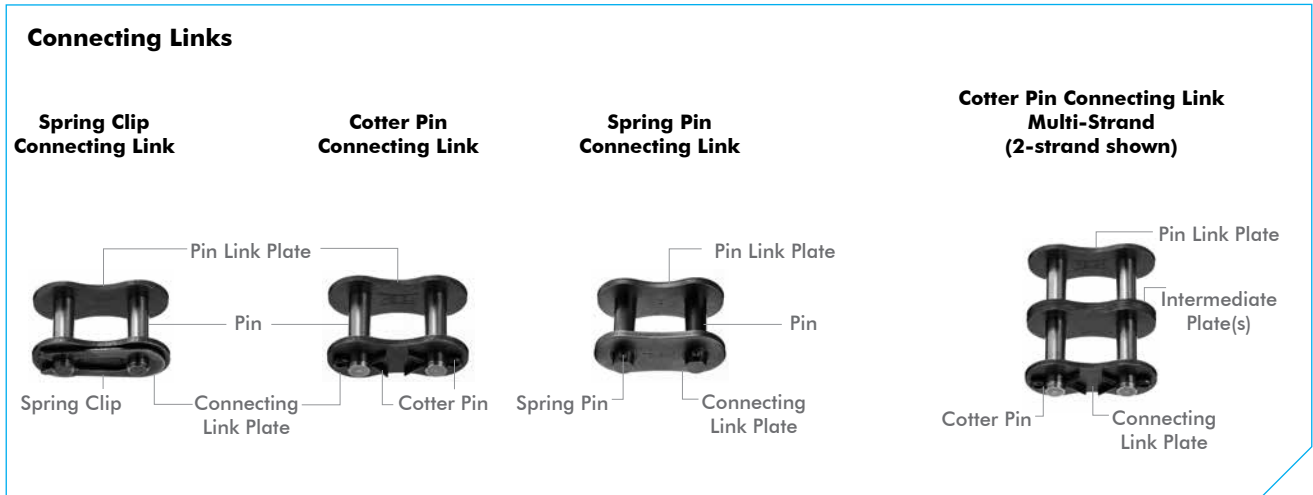

Pin Link and Intermediate Plate

The pin link consists of two pins that have been press fit into two pin link plates. In case of multi-strand roller chain up till size 08B, an intermediate plate is added to the pin link. In case of multi-strand roller chain above size 08B, two intermediate plates are added to the pin link. The intermediate plates are slip fit for standard roller chain and press fit for SUPER roller chain.

3. Assembly Parts

Roller chains are usually made up of a number of inner and outer links in an endless formation. Although offset links can be used when there is an odd number of links in the roller chain, it is better to use a design that requires an even number of links. If an odd number of links cannot be avoided, it is recommended

to use a two-pitch offset link in stead of a one-pitch offset link. As it is riveted into the chain, a two-pitch offset link has a 100% Maximum Allowable Load (applicable to ANSI chain), where as the one-pitch offset link has a Maximum Allowable Load of 65% (applicable to ANSI chain).

Connecting Links

There are three types of connecting links: spring clip connecting link, cotter pin connecting link and spring pin connecting link.

It's common to use slip fit spring clip connecting links for small size roller chains. Cotter pin and spring pin connecting links are used for large size roller chains and on customer request.

Chain Type	Connecting Link Plate Fastening Method	Size	Note
Standard RS Roller Chain	Spring Clip	up to RS16B / RS60	For multi-strand chain, make sure the plate with Ring Coins is on the outer most side when assembling.
	Cotter Pin	from RS20B / RS80	
	Spring Pin	RS240	
Lambda Roller Chain	Spring Clip	up to RS16B / RS60	Ring Coining process is carried out on the connecting plates.
	Cotter Pin	from RS20B / RS80	
SUPER Roller Chain	Spring Pin	All	Ring Coining process is carried out on the connecting plates.
SUPER-H Roller Chain ULTRA SUPER Roller Chain	Spring Pin	All	Please use exclusive connecting links for each chain type.
RS-H and RS-HT Roller Chain	Cotter Pin	upto RS200	Please use the exclusive connecting links for RS- HT Roller Chain.
	Spring Pin	RS240	
Heavy Duty Roller Chain	T Pin	All	There are no connecting links, so use connecting pins for assembly.
Other Roller Chain in Catalogue	Cotter Pin Spring Clip Spring Pin T Pin / Z Pin		Refer to the dimension tables of each chain. Chains that have a Ring Coin on the connecting plates: NP Roller Chain, N.E.P. Roller Chain and SNS Roller Chain.

1. INTRODUCTION TO TSUBAKI ROLLER CHAIN

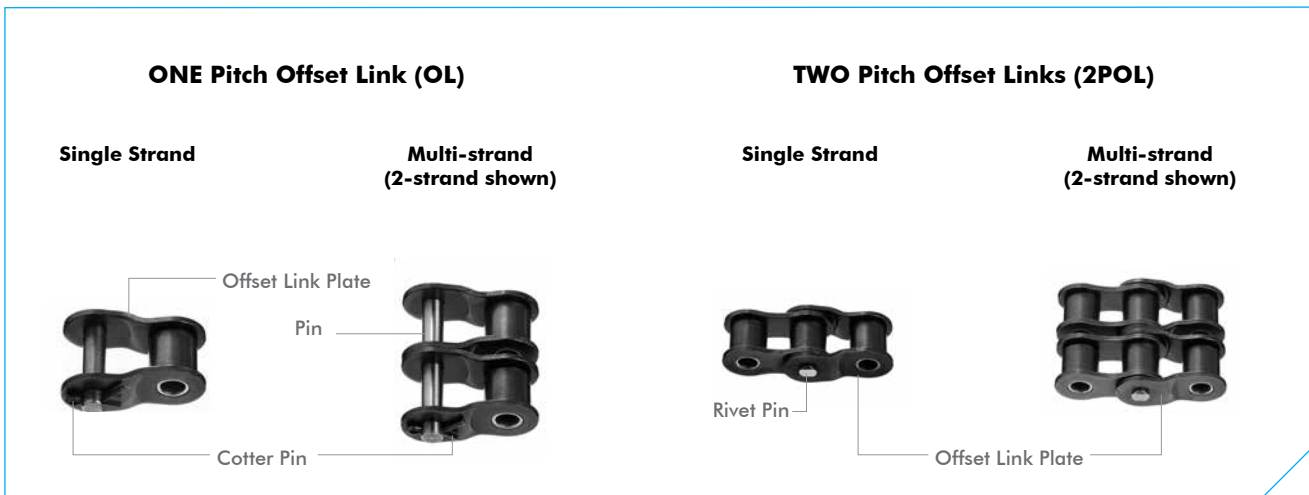

Offset Links

An offset link is used when an odd number of chain links is required. Different types are available:

One pitch offset link (OL)

The pin and two plates are slip fit. The maximum allowable load is 35% (applicable to ANSI chain) lower than the chain itself.

Two pitch offset link (2POL)

Two pitch offset links are the combination of a roller link and an offset link connected with a rivet pin. The maximum allowable load for ANSI chain is higher compared to the one pitch offset link. Please refer to the dimension tables for roller chain types and sizes suitable for offset links.

2. ORDERING TSUBAKI ROLLER CHAIN

When ordering TSUBAKI roller chain, please specify the chain size and material as well as the chain length and the installation position. For product codes and specifications, see the model identification examples below and dimension tables in Catalogue 1, Drive Chain. With the exception of application specific chain, TSUBAKI roller chain is stocked by unit. The standard unit length for BS/DIN chain is 5 meter, while the standard unit length for ANSI chain is 3.05 meter (10 feet). The total length of each unit includes one connecting link. Please purchase additional connecting links if you intend to separate the chain into two or more sections or join chains to create a longer chain.

2.1 Chain Identification

BS Roller Chain identification examples:

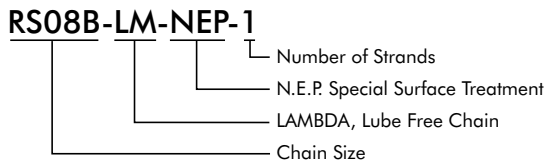
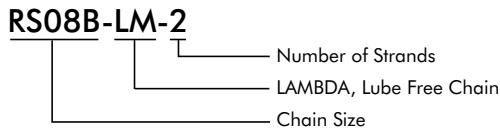
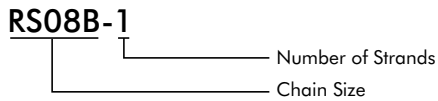

ANSI Roller Chain identification examples:

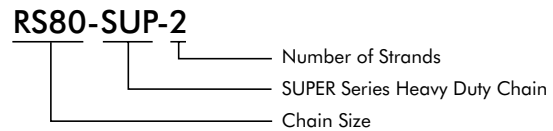
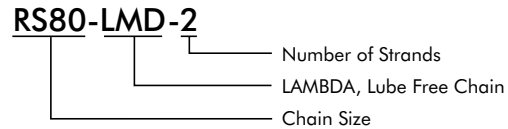
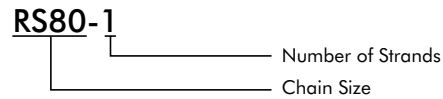

Chain number connecting link (CL): **RS08B-1-CL**
Chain number offset link (OL): **RS08B-1-OL**
Chain number 2 pitch offset link (2POL): **RS08B-1-2POL**

2. ORDERING TSUBAKI ROLLER CHAIN

2.2 Specific Ordering Procedure for Chain Length with an even Number of Links

A connecting link is supplied on one end of each unit and an inner link is supplied on the other end.

(a) Example of 8 links RS12B-1 including the connecting link



(b) Example of 20 links riveted endless chain RS50-1 (please specify "rivet endless"). There will be no CL supplied in this case.



2.3 Specific Ordering Procedure for Chain Length with an odd Number of Links

Please always specify the formation. Be careful with chain types for which there are no OL's. In case of an unspecified odd number of links, both end links will be treated as inner links.

(a) Example of 9 links



(Example order: RS50-1 Roller Chain 9 links; with OL and CL)

(b) When a 2 pitch offset link is specified



(Example order: RS12B-1 Roller Chain 9 links; with 2POL and CL)

(This combination is possible for RS Roller Chain only)

(c) Example of CL's on both ends



(Example order: RS16B-1 Roller Chain 9 links; with CL's on both ends)

2. ORDERING TSUBAKI ROLLER CHAIN

(d) Example of inner link on both ends



(Example order: RS50-1 Roller Chain 9 links; with inner link on both ends)

(e) Example of outer link on both ends



(Example order: RS12B-1 Roller Chain 9 links; with outer link on both ends)

For ease of understanding, the photos in the order examples above show assembled CL's and OL's. However, the parts are delivered separately when ordered. If you wish parts to be assembled, a configuration specification is necessary.

2.4 Ordering by the Reel

TSUBAKI Standard chain is available in fixed reel lengths.

TSUBAKI Chain No.	Length in Meter	No. of Links	No. of CL's included
RF06B-1	30.48	3200	10
RF06B-2	30.48	3200	10
RS08B-1	30.48	2400	10
RS08B-2	30.48	2400	10
RS10B-1	30.48	1920	10
RS10B-2	30.48	1920	10
RS12B-1	30.48	1600	10
RS12B-2	15.24	800	5
RS16B-1	15.24	600	5
RS20B-1	15.24	480	5
RS25-1	152.40	24000	50
RS35-1	60.96	6400	20
RS35-2	60.96	6400	20
RS40-1	45.72	3600	15
RS40-2	45.72	3600	15
RS50-1	30.48	1920	10
RS50-2	30.48	1920	10
RS60-1	30.48	1600	10
RS60-2	30.48	1600	10
RS80-1	15.24	600	5
RS100-1	15.24	480	5

2. ORDERING TSUBAKI ROLLER CHAIN

2.5 Ordering Replacement Chain

When the roller chain size is unknown, the following parameters are important to know:

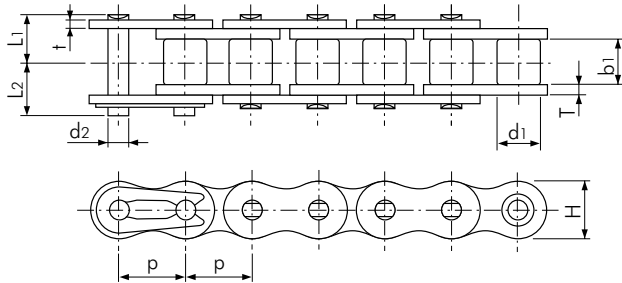

- Pitch (p)
- Inner Width (b_1)
- Roller Diameter (d_1)
- Pin Diameter (d_2)
- Plate Thickness (T, t)
- Plate Height (H)
- Shape of the Plate
- Logo on the Plate

It is equally important to confirm whether the chain is reinforced and what material is used.

You may need to verify the above with the equipment maker.

3. CUTTING TSUBAKI ROLLER CHAIN

If the chain you purchased is either a standard length or on a reel, you need to cut the chain to the necessary length. There are two relatively simple methods for disconnecting (cutting) roller chain. One way is to use a chain vice and punch. The other is to use a chain breaker.

3.1 Using a Chain Breaker

A chain breaker is a tool made for cutting chain. The chain breaker does not require a firm working table and can cut chain that is already set on a machine.



- For cotter pin type of roller chain, simply remove the cotter pin.
- For riveted type of roller chain, grind down two pin heads on the same side of an outer plate completely to the surface of that outer plate. (Be careful not to overheat the chain during the grinding process)
- Size RS08B-1 to RS16B-1 are "Easy Cutting" type so grinding down the pin head is not necessary.

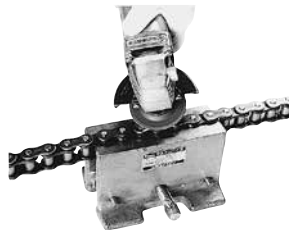
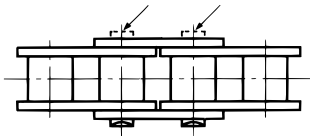

- Remove the two pins from the same outer plate using the chain breaker. Check to make sure the bushes from which the pins were removed have not come loose or deformed. Make sure not to re-use parts that have come loose or have become deformed.

3.2 Using a Chain Vice and Punch

- For cotter pin type of roller chain, simply remove the cotter pin.
- For riveted type of roller chain, grind down two pin heads on the same side of an outer plate completely to the surface of that outer plate. (Be careful not to overheat the chain during the grinding process)
- Size RS08B-1 to RS16B-1 are "Easy Cutting" type so grinding down the pin head is not necessary.
- Place the roller chain into the groove of the chain vice and tighten the vice to secure the roller to be disassembled.
(For multi-strand SUPER Roller Chain, put the far end roller into the groove of the chain vice.)

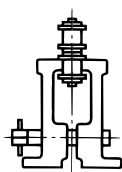

- Place the appropriate primary punch, according to chain size, on the head of the grounded pin, and then hit the head of the primary punch with a hammer. Make sure to hit the pins alternatively to ensure the pins are removed evenly and at the same time. Continue to tap the pin until just before the pin is removed from the outer plate.

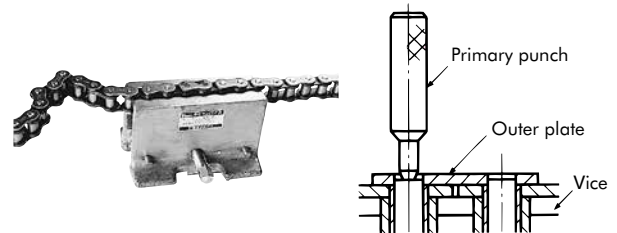

- Use the secondary punch to remove the pin completely from the outer plate. Check to make sure that the bush from which the pin was removed has not come loose or deformed. Make sure not to re-use this part if it did come loose or has become deformed.

Safety Precautions

- Make sure to grind off the riveted part of the pin. If the pin is extracted without grinding, it will take more time and effort and the chain may be damaged.
- Do not re-use any removed parts.

3.3 How to cut TSUBAKI Poly Steel Chain

- Support the outer plate of the chain in the cradle and push down on the pinhead with the exclusive punch. Then lightly hit the head of the punch using a hammer. Avoid using excess force on the engineering plastic part, as there is a possibility of causing damage.

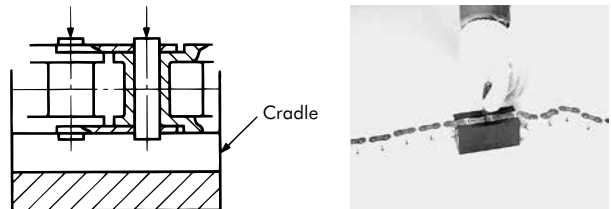

The available Chain Cutting and Chain Connecting Tools can be found in the back of this catalogue, on pages 78 and 79.

4. CONNECTING TSUBAKI ROLLER CHAIN

4.1 Connecting Roller Chain on Sprocket Teeth

When connecting or disconnecting roller chain, it is convenient to use the sprocket teeth.

Please carry out the following steps:

- Wind the chain around one of the sprockets so that both ends of the chain are facing each other on the sprocket.



- Apply oil or grease to the connecting link.
- Insert the connecting link in the two end links of the chain.
- Place the connecting link plate over the pins and fasten the plate using spring clips, cotter pins or spring pins.
- When using a press-fit connecting link, place the connecting link plate by tapping it with a hammer until it moves into the right position. Then fasten it by using the spring clips, cotter pins or spring pins supplied.
- When using the sprocket teeth to connect the chain, take care not to damage the teeth, particularly when using a cast iron sprocket.

4.2 Connecting Roller Chain between Shafts

If the layout prevents the use of sprocket teeth, please carry out the following steps:

- Wind the chain around the sprockets and pull the chain ends together using a chain puller or wire.

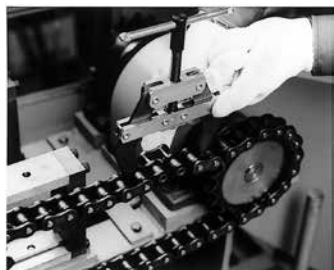

- Apply oil or grease to the connecting link.
- Insert the connecting link in the two end links of the chain.
- Place the connecting link plate over the pins and fasten the plate using spring clips, cotter pins or spring pins.

For both methods, be sure to tap the ends of the chain pins after the fasteners have been fitted. By tapping the ends of the pins, the fasteners will rest snugly against the outside of the connecting link plate. This will help the chain to articulate freely and smoothly as it goes around the sprocket in addition to allowing better lubricant penetration and greater fastener life. An offset link must be used where an odd number of pitches are required. Because the fatigue strength of an offset link is 35% lower than that of the base chain or a standard TSUBAKI connecting link, offset links should be avoided if possible. It is better to add one link and take up the extra slack by varying the centre distance between the shafts or by installing an idler.

4.3 Spring Clips and Cotter Pins

Spring clips

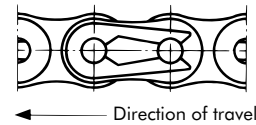

Spring clips are used for small size roller chain (under RS16B and RS60) connecting links. When connecting the chain, the clip should be inserted securely into the slot of the pin on the connecting link after the detachable plate has been placed on the pin. If the legs of the clips are spread too far they will not catch properly and will fall off during operation of the chain. Care should be taken when placing the clips. The direction in which the spring clip is installed is generally opposite to the direction of travel for the chain.

Cotter Pins

TSUBAKI cotter pins are treated for Standard, Heavy Duty and Lambda Chain. The legs of the cotter pins should be bent to an angle of approx. 60 degrees. Cotter pins should not be re-used, and commercially available cotter pins other than those produced by TSUBAKI should be avoided.

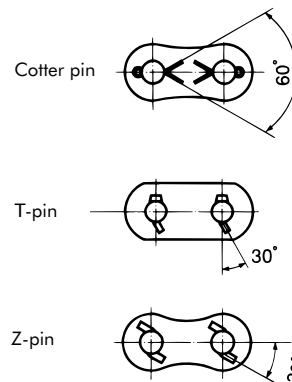

Safety Precautions

- Avoid using offset links wherever possible by varying the centre distance between shafts or by using an idler.
- In case the pins and connecting link plate holes are press-fit, please avoid widening the connecting link plate hole or narrowing the pin diameter to make connecting easier, as this will result in a reduction of the roller chain strength and may cause accidents.
- Do not re-use press-fit type link plates that have been detached, as the detachment results in a reduction of strength.

5. SPROCKETS

For maximum power transmission efficiency of a chain it is important to use high quality sprockets. The shape of the sprocket teeth is partly responsible for the wear of a chain. Sprockets also have influence on the noise level, life time and efficiency of the drive. The tooth configurations of TSUBAKI sprockets conform to BS/DIN & ANSI standards. All TSUBAKI sprockets are precision components with finely balanced boss and rim parts that are exactly in accordance with TSUBAKI's stated specifications.

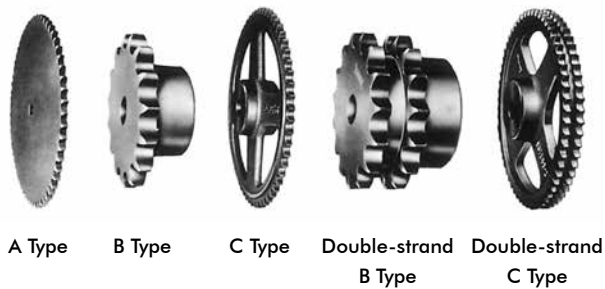

5.1 Sprocket Materials

Suitable sprocket material should be selected according to working conditions and requirements. Proper selection will result in higher performance and better cost effectiveness.

Sprocket Materials	
Type	Material
A	Low Carbon Steel
B	High Carbon Steel
C	Cast Iron

Other materials, such as stainless steel or plastic, are available on request.

5.2 Hardened Sprocket Teeth

Roller Chain is often used for high speed power transmission. To meet the requirement with simplex roller chain sprockets (RS08B-1 RS16B-1) with fewer teeth, the teeth are hardened by an induction hardening process.

Hardened sprocket teeth are required in the following situations:

- When the number of teeth is 24 or less, and the sprocket is used at a speed of 1/8 or higher of the maximum rotation speed shown in the power transmission capacity chart for the roller chain
- When using small sprockets and speed ratios over 1:4
- When applying heavy loads at low speed
- When using under abrasive conditions (on tooth)
- When using LAMBDA chain, TSUBAKI advises to use hardened teeth
- When using SUPER chain, TSUBAKI advises to use hardened teeth
- And also when using ULTRA SUPER chain, hardened teeth are necessary

5.3 Number of Teeth

A sprocket with as many teeth as possible should be used on the high-speed shaft side, to help ensure smooth drive transmission. Generally, 15 or more teeth should be used. However, when the speed ratio is high and the number of teeth on the low-speed sprocket exceeds 120, chain engagement problems can occur when there is even the slightest chain wear. In this case, decrease the number of teeth of the high-speed sprocket, but keep the number of teeth to 13 or higher. If the sprocket is used at extremely low speed and not subjected to shock, a sprocket with 12 or fewer teeth can be used.

5.4 Ordering Sprockets

Sprockets with less than 30 teeth can be delivered with hardened teeth. Sprockets with more than 40 teeth are normally made of cast iron. But TSUBAKI also has a large stock program of stainless sprockets.

Ordering Replacement Sprockets

When the sprocket number is unknown, the following parameters are important to know:

- Chain size and number of strands
- Number of teeth
- Sprocket type
- Shaft hole diameter (Not required when shaft hole processing is carried out in your company)
- Boss diameter and boss length
- Material
- Whether or not the teeth have been hardened
- Marking

In case the roller chain size is also unknown, please provide the following parameters as well:

- Width of teeth (T)
- Tooth bottom diameter (D_b)
- (D_c for an odd number of teeth)

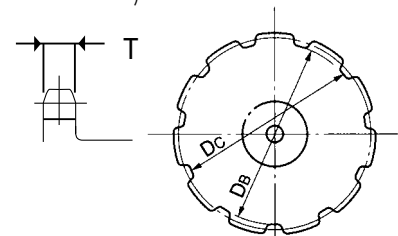

Example of order:
Standard sprocket

6 pieces RS12B-1 B20

Final bore sprocket with keyway
(shaft bore diam.: ø25 mm, key 8mm)

3 pieces RS50-1 B20 with bore 25H7, keyway 8J9

Material 304 Stainless Steel

1 piece RS12B-1 B20-SS

Engineering plastic made

1 piece RS50-1 B 20-P

6 INSTALLING TSUBAKI ROLLER CHAIN

6.1 Speed Ratio and Chain Lap

The speed ratio of roller chain can range up to 7:1 under normal operating conditions. However, a speed ratio of 10:1 is possible if the speed is very slow. Chain lap on the small sprocket must be at least 120° and at least 90° in case of a lifting chain.

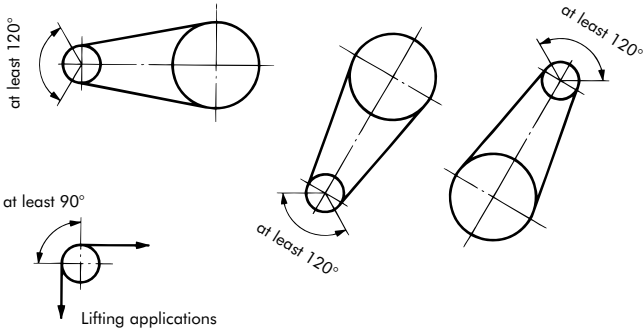

6.2 Distance between shafts

Sprockets can be separated by any distance as long as their teeth do not touch. Optimum centre-to-centre distance is 30 to 50 times the pitch of the chain. However, if the load is variable, the distance should not be more than 20 times the pitch of the chain.

6.3 Amount of Slack

It is not necessary to apply initial tension in roller chain transmission like with V-belt or Timing-belt transmission. In general, roller chain is used with a suitable amount of slack. If too much tension is applied to the roller chain, the oil film between the pins and bushes will be torn causing increased wear and damage on the roller chain and bearings. On the other hand, too much slack will cause the roller chain to vibrate, or ride up on the sprocket teeth resulting in damage to both the roller chain and the sprocket.

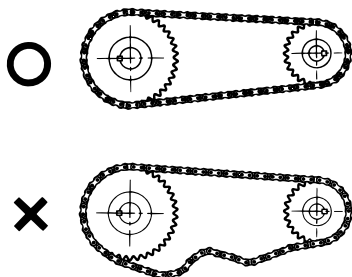

Generally, the slack of roller chain should be on the lower side. Adequate slack is calculated by moving the chain by hand in a downward direction from the centre. The chain slack that you move by hand (SS') should be about 4% of the span (AB) (Example: The amount of slack when span length is 800 mm would be $800 \text{ mm} \times 0.04 = 32 \text{ mm}$).

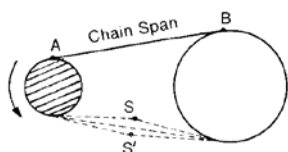

In the following cases, the slack should be about 2% of the span:

- Vertical drive or close to vertical drive (tensioner is required)
- Centre distance between two shafts is greater than 1 meter
- Chain is operated under heavy load and frequent starts
- Chain drive is suddenly reversed

After the assembly of a chain, TSUBAKI always applies an initial load, which is called a pre-load. The pre-load force approximates the recommended Maximum Allowable Load and is applied to seat the various chain components such as pins, bushes and link plates. The benefit of pre-loading is that it minimizes the initial elongation. Minimization of this initial elongation increases the chains service life therefore pre-loading is very important.

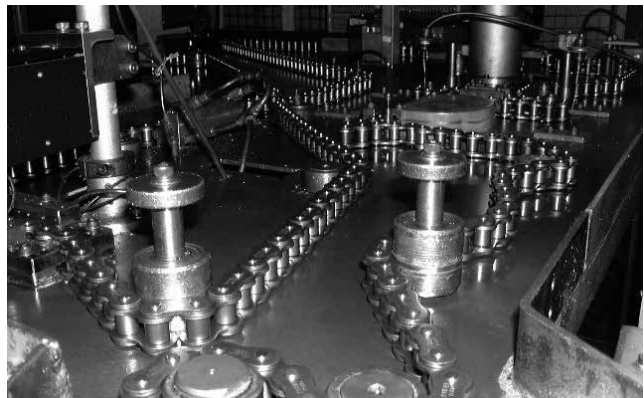

Roller chain tends to slightly elongate (about 0,05%) after initial operation. This initial elongation causes excess slack which needs to be adjusted accordingly. Please use a tensioner if the system has been designed for it. If, on the other hand, a tensioner is unsuitable, adjustment of the slack is achieved by moving the shafts. The chain will have now been used well, so elongation will significantly decrease.

6.4 Horizontal Precision and Parallelism of the Shafts

Proper alignment of sprocket and shaft is essential for smooth operation of the roller chain drive.

It also significantly influences the wear life of the roller chain. To ensure correct alignment, proceed as follows:

Make sure to carry out the following instructions correctly:

- 1) Check the horizontal precision with a level. Adjust the shafts so that they are horizontally within 1/300 precision.

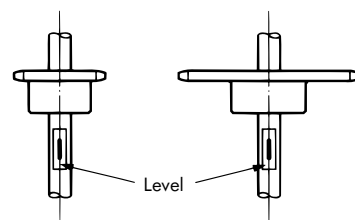

6 INSTALLING TSUBAKI ROLLER CHAIN

- 2) Check the parallelism with a scale. Adjust the shafts so that they are parallel to within $\pm \frac{1}{300} = \left(\frac{A-B}{L}\right)$

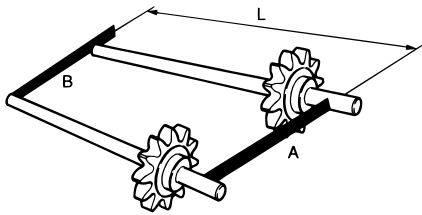

- 3) Using a straightedge or scale, adjust the two sprockets so that they are parallel. Adjust to within the following values based on the distance between the shafts.

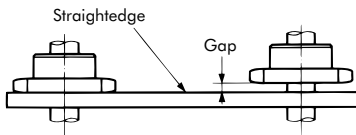

Centre Distance	Alignment Accuracy
up to 1 m	$\pm 1 \text{ mm}$
1 m to 10 m	Centre Distance (mm) / 1000
over 10 m	$\pm 10 \text{ mm}$

Misalignment can be measured with:

- A straightedge when the distance is short
- A piano wire when the distance is long
- A leveling string or a piano wire when the sprocket positions are different from each other in terms of sprocket height

- 4) Secure each sprocket to the shaft with a Power Lock, Lock Sprocket, Taper Bush or keys (if needed use a collar, bolt sets, etc.)

PRO-ALIGN professional laser alignment system is available from TSUBAKI.
Please consult TSUBAKI for further information if required.

Note:

- It is required that at least three sprocket teeth are engaged with the chain
- Installation of a take-up unit is an effective way to adjust for chain elongation
- It is required to phase teeth of sprockets when multiple strands of chain are used in parallel

6.5 Layouts

(☉ indicates the drive side in the illustrations)

- 1) General Layouts

Ideally the line connecting the sprocket centres in the roller chain transmission equipment should be close to level. If installation is close to vertical, it is desirable to install an idler or a guide shoe because even slight elongation can cause the chain to come off the sprocket. The angle of inclination should be kept within 60° .

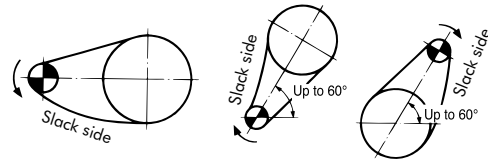

- 2) Layouts Requiring Attention

- If the slack is on the upper side and the driving distance is short, move the shafts to adjust the distance of the sprockets and slightly increase the tension.

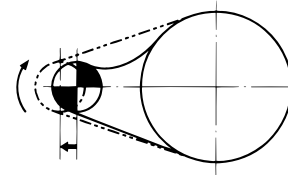

- If the slack is on the upper side and the driving distance is long, chain slack is adjusted by installing an idler, which supports the roller chain.

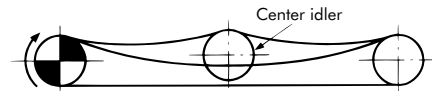

- If the chain speed is high and the load is pulsating, a guide will help to prevent vibration.

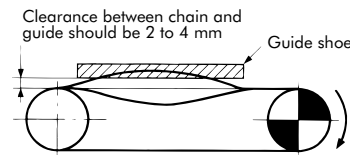

- If the centre line is vertical install a tensioner that can automatically eliminate the excess chain slack. This is particularly necessary when the drive shaft is on the bottom.

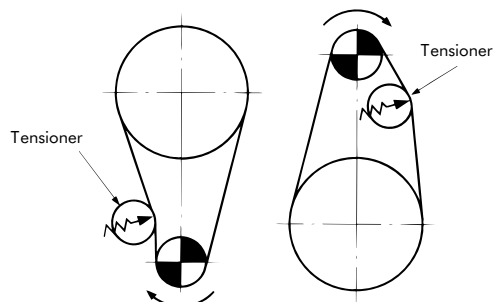

6 INSTALLING TSUBAKI ROLLER CHAIN

6.6 Installation of Curved Chain

- 1) Guide Installation
Compared to standard chain, curved chain has a larger gutter between the pins and bushes, providing a greater degree of freedom. Therefore, a chain guide should be installed to ensure that the chain directly engages with the sprocket.
- 2) Minimum Lateral Bending Radius (R).
The minimum lateral bending radius (R) should be greater than the specifications shown below.

Minimum Lateral Bending Radius (R) in mm

	Standard	Lambda	SS
RS40-CU	350	400	400
RS50-CU	400	500	500
RS60-CU	500	600	600
RS80-CU	600	-	800

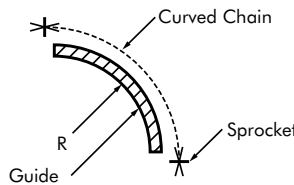

6.7 Pin Gear Drive

Generally speaking, roller chains and gears are used in a smaller centre-to-centre diameter circle resulting in a linear or rotary motion. However, in case the roller chain requires a larger space and gearing results in high cost, a pin gear drive is more suitable and consequently more economical.

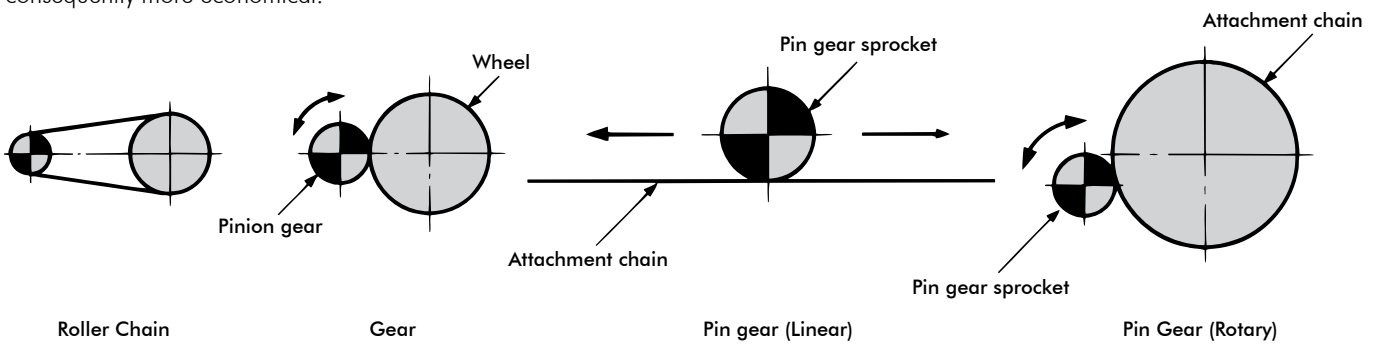

Pin gear drive uses roller chains. As wheel and pin gear sprocket engages with special tooth form sprockets when roller chains are installed on the outside of the drum. In case of linear motion, roller chains are laid straight instead of rack and pinion.

Item	Pin Gear Drive	Roller Chain Drive	Gear Drive
Restriction of centre distance between shafts	Limited	No limited	Limited
Engaged number of tooth	Small	Big	Small
Available speed ratio	No limited	Up to 1:7	No limited
Tooth shape	Special tooth	Sprocket tooth	Involute tooth
Engagement precision	Normal	Normal	Precision

- 1) Advantages of the Pin Gear Drive
 - a. In case the speed ratio is over 1:5 (especially when the outer diameter of the drum is large) Pin Gear Drive is the most economical method
 - b. It is easy to install the chain on the drum using bolts/attachments
 - c. Flexible design layout - diameter of drum and length of rack
 - d. Precision installation, like a gear, is unnecessary
 - e. Accessible for grease lubrication

Note: Pin Gear Drive is not suitable for Precision Drive and it is noisier than Gear Drive

6 INSTALLING TSUBAKI ROLLER CHAIN

2) Installation of the Pin Gear Drive and Precautions

- a. If used linearly (rack) with rollers facing up:
- Standard roller chain

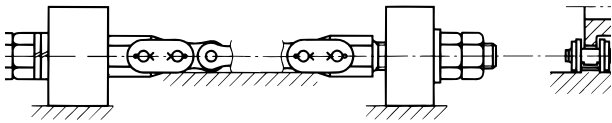

Fasten the CL's on each end of the chain with bolts and nuts to remove slack. Please use double nuts to avoid bolts loosening. (This is not recommend if tooth slipping and interference can occur)

- Attachment chain

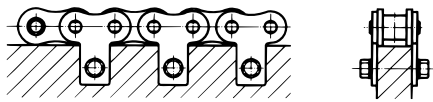
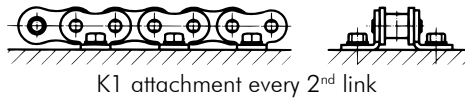

Please install the chain with SK1 or K1 attachment every 2nd link and fasten every 2nd or 4th link with bolts pulling the chain straight, in order to avoid slack and misalignment.

We recommend K1 attachment over SK1 attachment. Please use the bolts with tensile strength over 800N/mm².

- b. If used linearly (rack) with rollers facing down:

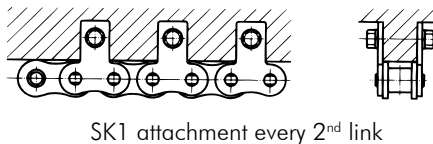
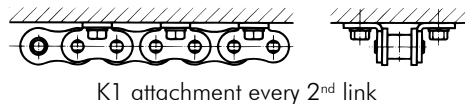

Please install the chain with SK1 or K1 attachment every 2nd link and fasten every 2nd or 4th link with bolts pulling the chain straight, in order to avoid slack and misalignment.

- c. If wrapped partially or totally around the outside of a drum:

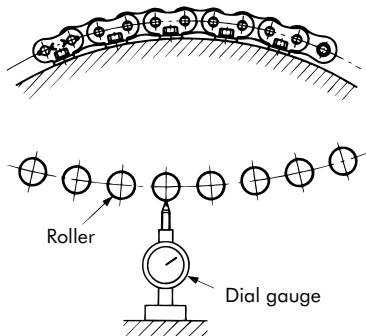

- For Tsubaki, the allowable length tolerance of attachment chain is within 0% to +0.20%. Therefore, you need to adjust the slack between the chain and the drum with shims.
- K attachment is easier to attach to the drum than SK attachment since shims can be used.
- In case the drum is not perfectly round, the thickness of the shims needs to be adjusted while the chain is wrapped around the drum, so that the radius becomes circular.

- d. If installed partially or totally on the inside of a drum: Please contact TSUBAKI

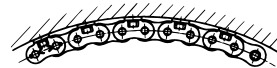

- e. If used for lateral Pin Gear Drive: Please contact TSUBAKI

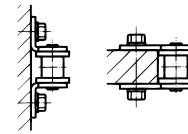

- f. Installation of the sprocket

- Please adjust the position and angle of the shaft to contact the chain at right angles.
- The clearance (a) between the rollers and the bottom of the sprocket teeth should be less than the dimension shown in the following table. The bottom of the teeth and rollers should not touch each other.

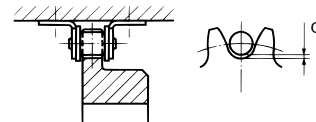

Chain size	a
Up to RS16B and RS80	1.0 mm
RS20B~RS32B, RS100~RS180	1.5 mm
Over RS40B and RS200	2.0 mm

7. LUBRICATION

One of the most important factors in getting the best possible performance from your roller chain is proper lubrication. Particularly when performance requirements become more severe, the need for lubrication becomes more and more important.

No matter how well a transmission system is designed, if it is not properly lubricated its service life will be reduced. Since service life may be completely used up in a short period of time, depending on the operating conditions, please pay particular attention to lubrication. Most TSUBAKI drive chains are pre-lubricated (Stainless Steel Chain and Low Temperature Chain are not)

- 1) The main purpose of lubricating and greasing is to limit wear elongation and prevent corrosion of the chain. Wear elongation arises from wear between the pin and bush when the chain articulates.
- 2) TSUBAKI roller chain is pre-lubricated before packing. Since high-grade oil with a rust protection and lubricating effect is used, it limits the amount of wear elongation during the initial operation and ensures wear resistance.
- 3) Lubrication on the supplied chain should not be wiped off with a cloth or washed off with solvents such as detergents.

7.1 Progress of chain elongation

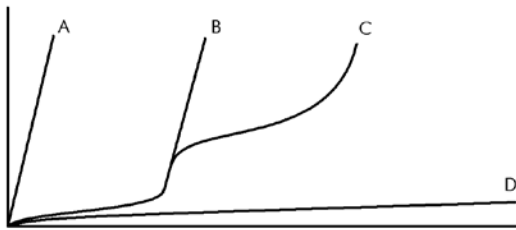

Line A shows rapid wear elongation when the chain is operating in no lubrication.

Line B shows wear progress of the chain initially lubricated by the chain manufacturer. While the initial lubricant is performing, the chain gradually elongates. Due to no additional lubrication, the chain starts to elongate rapidly afterwards.

Line C shows the case of intermittent lubrication to the chain.

Line D shows ideal progress under sufficient lubrication of the chain all the time.

7.2 Lubrication Position

- 1) Since wear elongation is caused by wear between the pins and bushes, lubrication must be carried out on these parts.
- 2) The clearance between the outer plate and the inner plate on the slack side of the chain should be lubricated with oil. The clearance between the bush and the roller should also be done at the same time.

Lubrication Position

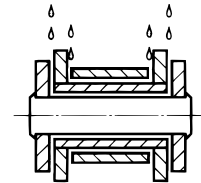



7.3 Chain used for lifting

- 1) In general the chain has no catenary parts. If possible, remove the load that acts on the roller chain before lubricating the chain.
- 2) For roller chain that does not articulate, oil the chain sufficiently and then apply a thick layer of grease around the roller chain to prevent corrosion. Sufficiently lube end fitting connections, even if these do not move.
- 3) For roller chain that is used outdoors, contact with rain and snow will remove the lubrication and cause harmful corrosion, and thus a cover or other protection should be installed.

If rain or snow does fall on the chain, remove the moisture and then promptly lube the chain and coat it with a thick layer of grease.

7. LUBRICATION

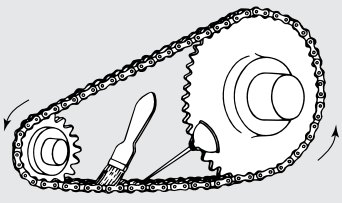
7.4 Recommended Lubrication; Systems and Methods

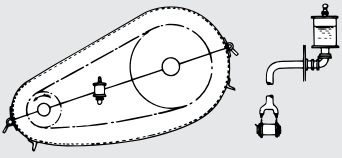
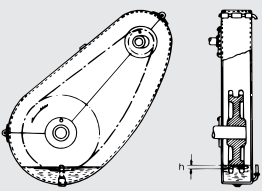
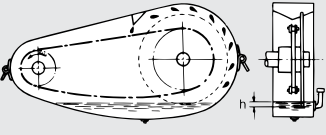
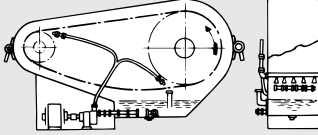
Lubrication system	Method	Quantity																																		
A	Brush / Oil filler  <p>“Apply oil with an oil filler or brush between pin/bush and bush/roller on the slack side of the chain”</p> <div style="border: 1px solid black; padding: 5px; display: inline-block;">  Stop operation before oiling. </div>	Oil with sufficient frequency (in general about once every 8 hours) so that the roller chain bearings do not dry out.																																		
	Drip Lubrication  <p>Using a simple case, this method drips oil supplied from an oil cup.</p>	For one strand of chain, drip about 5 to 20 drops of oil each minute. Drip more oil on higher speed chains.																																		
B	Oil Bath  <p>The chain is run through oil in a leakfree casing.</p>	If depth h from the surface of the oil to the lowest point the chain reaches is too deep, the oil may heat up (80°C or higher) and deteriorate. The depth to which the chain descends in the oil should be about 6 to 12 mm.																																		
	Lubrication using a Slinger Disc  <p>Use a slinger disc attached to a leak free case to splash oil on the chain. The peripheral velocity of the disc should be 200 m/min or higher. If the width of the chain is greater than 125 mm, attach discs to both sides.</p>	The lowest point h reached by the slinger disc should be about 12 to 25 mm below the surface of the oil. The roller chain should not enter the oil.																																		
C	Forced Lubrication  <p>The oil is circulated in a leak-free case and cooled by a pump. When there are n strands of chain, n+1 oiling holes are required, targeting the gaps between each part.</p>	Approximate oiling quantity per oiling hole (L/min) <table border="1" style="margin-top: 10px;"> <thead> <tr> <th rowspan="2">Name</th> <th rowspan="2">Chain pitch Chain speed (m/min)</th> <th colspan="4">Chain pitch</th> </tr> <tr> <th>3/4" pitch or smaller</th> <th>1" ~ 1/4"</th> <th>1 1/2" ~ 1 3/4"</th> <th>2" or larger</th> </tr> </thead> <tbody> <tr> <td>RS</td> <td>500 – 800</td> <td rowspan="2">1.0</td> <td rowspan="2">1.5</td> <td rowspan="2">2.5</td> <td rowspan="2">4.0</td> </tr> <tr> <td>SUP</td> <td>Less than 300</td> </tr> <tr> <td>RS</td> <td>800 – 1,100</td> <td rowspan="2">2.0</td> <td rowspan="2">2.5</td> <td rowspan="2">3.5</td> <td rowspan="2">5.0</td> </tr> <tr> <td>SUP</td> <td>300 – 500</td> </tr> <tr> <td>RS</td> <td>1,100 – 1,400</td> <td rowspan="2">3.0</td> <td rowspan="2">3.5</td> <td rowspan="2">4.5</td> <td rowspan="2">6.0</td> </tr> <tr> <td>SUP</td> <td>500 or more*</td> </tr> </tbody> </table> <p>* according to kW rating table</p>	Name	Chain pitch Chain speed (m/min)	Chain pitch				3/4" pitch or smaller	1" ~ 1/4"	1 1/2" ~ 1 3/4"	2" or larger	RS	500 – 800	1.0	1.5	2.5	4.0	SUP	Less than 300	RS	800 – 1,100	2.0	2.5	3.5	5.0	SUP	300 – 500	RS	1,100 – 1,400	3.0	3.5	4.5	6.0	SUP	500 or more*
Name	Chain pitch Chain speed (m/min)	Chain pitch																																		
		3/4" pitch or smaller	1" ~ 1/4"	1 1/2" ~ 1 3/4"	2" or larger																															
RS	500 – 800	1.0	1.5	2.5	4.0																															
SUP	Less than 300																																			
RS	800 – 1,100	2.0	2.5	3.5	5.0																															
SUP	300 – 500																																			
RS	1,100 – 1,400	3.0	3.5	4.5	6.0																															
SUP	500 or more*																																			

To verify sufficient lubrication is taking place, remove the chain and inspect the connecting pins and bushes. If the contact surfaces of the pins or bushes show tearing or a red or dark brown color, lubrication is generally not sufficient.

7. LUBRICATION

7.5 Recommended viscosity

ISO Viscosity Group

Lubrication system	Brush, Drip or Oil Bath (A1, AII, B)				Forced Lubrication (C)			
	-10°C to +0°C	+0°C to +40°C	+40°C to +50°C	+50°C to +60°C	-10°C to +0°C	+0°C to +40°C	+40°C to +50°C	+50°C to +60°C
Ambient temperature								
RS10B/RS50 and under	32	68	100	150	32	68	100	150
RS12B/RS60 RS16B/RS80	68	100	150	220				
RS20B/RS100					100	150	220	
RS24B/RS120 and over								68

Lubrication system	Brush, Drip or Oil Bath (A1, AII, B)				Forced Lubrication (C)			
	-10°C to +0°C	+0°C to +40°C	+40°C to +50°C	+50°C to +60°C	-10°C to +0°C	+0°C to +40°C	+40°C to +50°C	+50°C to +60°C
Ambient temperature								
RS10B/RS50 and under	SAE10W	SAE20	SAE30	SAE40	SAE10W	SAE20	SAE30	SAE40
RS12B/RS60 RS16B/RS80	SAE20	SAE30	SAE40	SAE50				
RS20B/RS100					SAE30	SAE40	SAE50	
RS24B/RS120 and over								SAE20

7.6 Recommended Lubricants

TSUBAKI Europe can supply chain with special lubrications; we use 6 different types of lubricant, suitable for each application. Of course it is also possible to apply a lubricant at your specifications. Or, the chain can be lubricated after assembly by you, using a lubricant specified by TSUBAKI.

Category
High performance
High temperature (+0 to +250°C)
Low temperature (up to -45°C)
Food-safe (USDA H1 approved)
Outdoor exposure
Dusty environment



7.7 Automatic lubricator

An Automatic Lubricator can be used to be ensured of precise and reliable lubrication.

8. CHAIN TEST RUN

After installing the chain, carry out a test run and check the following items before you actually start running the chain.

8.1 Before beginning Test Run

- 1) Connecting link plates, clips, and cotter pins are installed correctly.
- 2) Chain slack has been properly adjusted.
- 3) Adequate lubrication is available.
- 4) The chain isn't touching any objects, such as chain cases, etc.
- 5) There are no obstacles in the chain operating area, and all is clean.

8.2 Test Run

- 1) **Sound**
There should be no strange noises. Make sure the chain doesn't touch the case.
- 2) **Vibration**
Look for excessive chain vibration.
- 3) **Sprocket-chain interaction**
Make sure the chain doesn't climb over the sprockets.
- 4) **Sprockets**
Ensure that the chain separates smoothly from the sprocket.
- 5) **Chain articulation**
The chain should articulate smoothly.

If you notice any of the above conditions, do not begin operation. Correct any problems before proceeding any further.

9. ROLLER CHAIN INSPECTION

In general, life of roller chain is determined when parts are damaged or when there has been 1.5% wear elongation. The chain's wear elongation limit varies according to the number of sprocket teeth and their shape. Upon calculations, we see that sprockets with large numbers of teeth are very limited in stretch percentage. Smaller sprockets are limited by other harmful effects, such as high vibration and decreasing strength; therefore, in case of less than 60 teeth, the stretch limit ratio is limited to 1.5 percent (in transmission chain).

If roller chain selection and operating conditions are suitable, you can expect a long life and troublefree operation from the chain. However, wear will progress between the pins and bushes after a long period of time, so we have described some matters below, which should be noted and inspected.

9.1 Inspection Checklist

Procedures	Method	Inspection Items	
Step I	Visually check the chain during operation and look for any abnormalities.	<ol style="list-style-type: none"> 1. There should be no strange noises. 2. Look for excessive chain vibration. 3. Make sure the chain does not run up the sprockets. 4. The chain is not jammed into the sprockets. 5. There are no stiff areas during articulation. 6. Adequate lubrication is available (lubricating system and quantity of oil). 7. Make sure the chain doesn't touch the case. 	
Step II	Stop the chain and carefully inspect each part of the chain and sprocket.	<ol style="list-style-type: none"> 1. Check the external cleanliness, corrosive, and lubrication conditions; also, look for scratches or other damage to the plate side and edge surfaces, pin edges, and roller surfaces. 2. Inspect for pin rotation and the clearance between the plate and the pins. 3. Inspect the sprocket teeth surfaces and teeth side surfaces for scratches or marks. 4. Measure the wear elongation of the chain. 5. Check the articulation of the chain and rotation of the rollers. 6. When using an end fitting for lifting applications, inspect the wear of the end bolts and the wear of the connecting plate pins. Also, check for proper installation at the same time. 	Inspection points are on the following pages and on the troubleshooting pages.
Step III	In order to investigate in more detail, remove the roller chain and inspect it visually or check it with measuring instruments.	<ol style="list-style-type: none"> 1. The inspection items are identical to those in Step II except in more detail. 	

9. ROLLER CHAIN INSPECTION

9.2 Inspection Intervals

Regular inspection of roller chain is recommended at one month intervals. Inspection should be carried out at shorter intervals in the following cases.

- Special or corrosive environments
- High speeds with sudden stoppage
- Lifting or indexing operations

9.3 Inspection requirements for ordinary transmission

1) Inspection of the lubrication condition

- While the chain is driving, check to see if there is lubrication in the clearance between the outer plate and inner plate. Also check if the chain or rotating disc is immersed in lubricating oil.
- When the chain is stationary, the chain surface will generally appear dirty from wear dust if lubrication is unsatisfactory. This is especially the case between the link plates.
- When the chain is removed, connecting link pins and the edge of the inside of the bushes should be checked. If there are any scratches, red or reddish brown colour, lubrication is improper or insufficient.

2) Inspection of the link plates

- If repeated loads over the maximum allowable load are put on the chain, there is a strong possibility of fatigue breakage of the link plate. It is difficult to notice initial cracking from fatigue breakage simply from external observation.

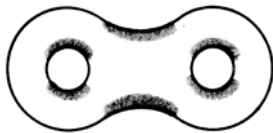

Positions where cracks are likely to develop



Example of a crack

- Usually, a crack develops at the edge of a hole or at the side of the link plate. The presence of cracks should be checked carefully. Fatigue breakage progresses little by little, so it can be noticed if close attention is paid.
- When wear occurs from sliding between the edges of the plates and the guides, it is necessary to adjust the position of either the chain or the guides. The allowable wear on the link plates is limited to 5% of their height.

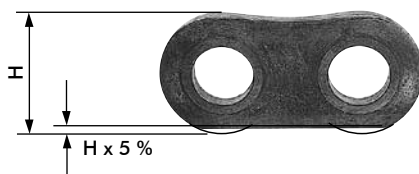

3) Inspection of the pins

- When the pins rotate, the roller chain must be completely replaced with new chain. This also applies to the connecting pins. By removing the connecting parts it is possible to see the conditions of wear and rust on the surfaces of the pins.

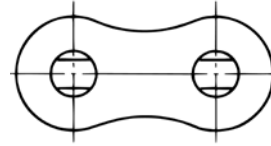

Correct position of pins

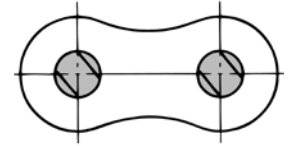

Rotated position of pins

4) Inspection of the rollers

- As with the link plates, if rollers are also subjected to loads over the maximum allowable load, the repeated impact load between the chain and the sprockets may cause fatigue breakage to occur. The roller should be checked in the same way as the link plate.
- If foreign objects interfere with the engagement of the roller and sprocket, the roller may be damaged and a crack may develop. Careful attention should be paid to the above.
- Furthermore, with high-speed operations, even if foreign objects do not interfere with engagement, cracks may appear from the impact with the sprocket teeth.



Cracks on the rollers

- Chains damaged from fatigue breakage of the rollers must be completely replaced, because each part has received the same amount of repeated load.
- Also check if the roller rotation is poor.

5) Inspection of the sprockets

- Chain and sprocket engagement can be checked by observing the roller and surface of the teeth. Proper engagement is when the contact area is uniform with point A in the illustration. If the contact area is lopsided or the sides of the teeth are wearing away (point B), this may have been caused from improper installation of the sprockets or twisting of the roller chain. In this case, rechecking/readjustment is necessary.
- The normal point of impact is slightly up from the tooth bottom. However, when initial tension is applied to the chain and tension remains on the slack side, the roller will slightly touch the tooth bottom. However, point A receives the strongest impact.
- When idlers or tensioners are used, the contact area will be the centre of the tooth bottom.

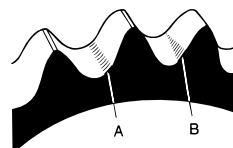

B: Improper installation

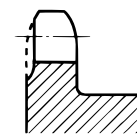

Improper installation causes the surface of the teeth to become ground down.

Contact area of the sprocket teeth.

9. ROLLER CHAIN INSPECTION

- When wear on the teeth reaches the values in the following table, lifespan of the sprocket has been reached. For a sprocket with induction hardened teeth, the lifespan is reached when the hardened layer has been removed.

Size of BS Roller Chain	Dimension B Normal / Pin-Gear	Size of ANSI Roller Chain	Dimension B	
			Normal	Pin-Gear
RS05B	1.6	RS 11	0.6	-
RF06B	1.6	RS 15	1.1	-
RS08B	2.1	RS 25	1.5	-
RS10B	2.9	RS 35	2.5	-
RS12B	3.6	RS 41	2.6	-
RS16B	5.0	RS 40	2.5	3.1
RS20B	6.8	RS 50	2.9	3.6
RS24B	7.2	RS 60	3.7	4.6
RS28B	8.6	RS 80	5.0	6.3
RS32B	11.9	RS100	6.9	8.6
RS40B	12.7	RS120	8.7	10.9
		RS140	10.6	13.3
		RS160	12.4	15.5
		RS180	11.3	14.1
		RS200	12.6	15.8
		RS240	15.1	18.9

Limit of usage (in mm) based on tooth thickness / Dimension B

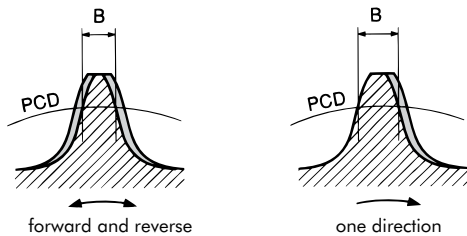

- If a new roller chain is run on a worn sprocket, the chain will wear at a faster rate than normal. In this case, when replacing the chain, replacement of the sprocket is also recommended.

6) Inspection of chain elongation

- Chain elongation is caused not by deformation of the link plate, but by wear on the pin and bush. Therefore, the remaining chain life can be estimated by periodically measuring the chain elongation.
- Measuring chain elongation:
 - The chain should be measured whilst stretching it slightly to eliminate any slack.
 - Measure the distance of the inside (L1) and outside (L2) of the rollers at both ends of the measured links using a vernier calipers, to get a measurement (L).

$$L = \frac{L1 + L2}{2}$$

- When measuring, use at least 6 to 10 links to help keep any measuring error down to a minimum.

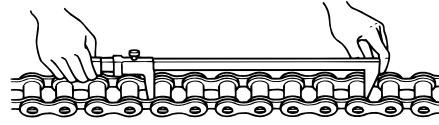

Positioning of vernier calipers for measuring 6 links

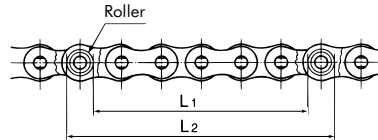

Measurement of length

- Finding the chain elongation

$$\text{Chain elongation (\%)} = \frac{\text{Measured length} - \text{Standard length} \times 100}{\text{Standard length}}$$

$$\text{Standard length} = \text{Chain pitch} \times \text{Number of links}$$

- For multi-strand roller chain, the measurement is carried out in the same way as for single strand roller chain of the same pitch.
- The limit of usage based on roller chain elongation for a smooth transmission is as follows.

7) Allowable Elongation / Number of Teeth

Sprocket Size	Allowable Elongation
Large sprocket with up to 60 teeth	Chain elongation 1.5%
Large sprocket with between 61 - 80 teeth	Chain elongation 1.2%
Large sprocket with between 81 - 100 teeth	Chain elongation 1.0%
Large sprocket with between 101 -110 teeth	Chain elongation 0.8%

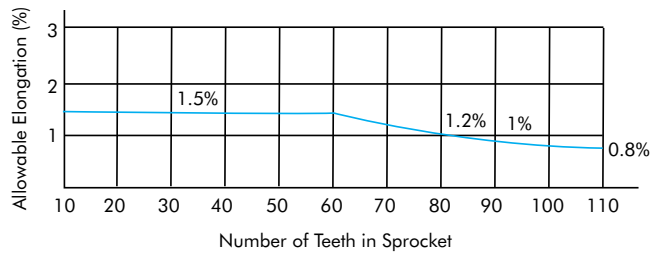

Limit of usage based on elongation

A chain wear measurement scale that allows easy checking of elongation is available from TSUBAKI.

9. ROLLER CHAIN INSPECTION

8) Measuring long length

When the length of the roller chain cannot be measured with a vernier calipers, a tape measure may be used; however, measurements need to be taken over as many links as possible to reduce measuring error.

9) Lifespan of Lambda / X-Lambda roller chain.

When chain elongation of Lambda Roller Chain reaches about 0.5% it may be losing its lubricating properties. This may be determined by the adhesion of red wear particles between the plates and the occurrence of articulation stiffness. When this occurs, the life of the chain has been reached.

Dimensions for evaluating standard length (chain pitch x number of links) and 1.5% elongation are shown in Table below.

Chain No.		05B	06B	08B	10B.	12B	16B	20B	24B	28B	32B
6 Link	Standard Length	48.00	57.15	76.20	95.25	114.30	152.40	190.50	228.60	266.70	304.80
	Measure 1.5% Elongation	48.72	58.01	77.34	96.68	116.01	154.69	193.36	232.03	270.70	309.37
10 Link	Standard Length	80.00	92.25	127.00	158.75	190.50	254.00	317.50	381.00	444.50	508.00
	Measure 1.5% Elongation	81.20	96.68	128.91	161.13	193.36	257.81	322.26	386.72	451.17	515.62

Chain No.		40B	48B
6 Link	Standard Length	381.00	457.20
	Measure 1.5% Elongation	386.72	464.06
10 Link	Standard Length	635.00	762.00
	Measure 1.5% Elongation	644.53	773.43

9.4 Storage

Avoid storing spare parts, such as a roller chain, sprockets, in high temperature/high humidity and dusty environments. Also, when storing roller chain that has been removed, wash the roller chain and then apply lubrication. After the roller chain clearances have been supplied with a sufficient amount of lubricant, wrap the chain in grease paper completely before storing away.

10. CAUTIONS ON USE IN SPECIAL ENVIRONMENTS

As a general rule, roller chain should be used in a clean air flow; however, when used in a special atmosphere, reference should be made to the various items that follow.

10.1 Use in wet conditions

If the chain is used in a sterilizing machine or water screen, for example, where the chain is splashed with water or goes through heated vapour, the following problems may occur:

- An increase in abrasive stretch due to improper or insufficient lubrication.
- Decrease in fatigue strength from rust and corrosion (pitting) of the chain.

Countermeasures

- Reduce bearing pressure using a larger sized chain to improve wear resistance.
- Use corrosion resistant roller chain for rust prevention.

10.2 Use in acidic or alkaline conditions

If roller chain is exposed to acidic or alkaline conditions, such as battery acid and liquid used in plating processes, the following problems may occur:

- Embrittlement fracture of link plates and pins.
- Fatigue breakage of link plates and pins due to rust and pitting corrosion.
- Wear from usual mechanical abrasion and corrosion.
- Reduction in volume of the whole chain from corrosion.
- In special cases where the chain is underwater (immersed in liquid), electro chemical corrosion may occur.



Corrosion of stainless steel roller chain

- There are also circumstances where even stainless steel roller chain will corrode. Above picture shows an example of chain that was used in a plating apparatus. The chain failed within one month due to the affect of the acid.

Countermeasures for embrittlement fractures (Stress corrosion cracking)

- Adopt a brittleness countermeasure that lowers crack susceptibility.
- Install a cover or casing to prevent acids or alkalis from contacting the chain.
- Adopt a high-grade material with anti-corrosive properties.

Countermeasures for corrosion

- Use surface-treated chain.
- Install a cover or casing to prevent acids or alkalis from contacting the chain.
- Adopt a high-grade material with anti-corrosive properties.



Hydrogen embrittlement cracking

In general, embrittlement fractures (stress corrosion cracking) occur around the link plate holes. This is the area where the pin and bush are press-fitted to the link plate having the highest concentration of stress. Cracks are generated even when there is no tension on the chain. Roller chain in general is more susceptible to acids than alkalis, and in special cases, embrittlement fractures (stress corrosion cracking) are generated by seawater or pit water.

10.3 Use under conditions where abrasion is a problem

If the chain is exposed to strong abrasive materials that promote wear such as sand, coke and metal particles, the following problems may occur:

- When the abrasive materials penetrate between the pins and bushes, chain wear is promoted and poor articulation occurs.
- When the abrasive materials penetrate between the bushes and rollers, chain wear is promoted and poor roller rotation occurs.
- When the abrasive materials penetrate between the link plates, poor articulation occurs.

Countermeasures

- Apply a dust-protection casing.
- Remove foreign particles by regularly washing the roller chain.
- Reduce bearing pressure using a larger sized chain to improve wear resistance.
- Increase abrasion resistance by applying special processing to the parts of the chain where abrasion is a problem.



10.4 Corrosion Resistance Guide

Since corrosion resistance varies substantially according to operating conditions, this chart should not be considered as a guarantee. Using this chart as a reference, make sure to check the corrosion resistance of the chain in advance according to the actual operating conditions before deciding on the type of chain to use. The Corrosion Resistance Guide can be found in the back of this catalogue, on pages 80 and 81.

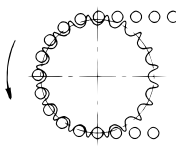
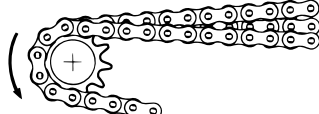
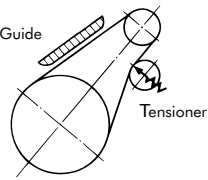

* For slightly corrosive environments N.E.P. chain is also available.

11. ROLLER CHAIN TROUBLESHOOTING AND PROBLEM SOLVING

11.1 General



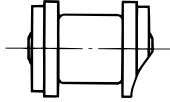

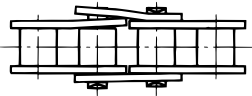
Symptom	Possible Causes	Solution
 <p>Chain rides up on the sprocket</p>	Chain and sprocket do not match.	Replace the chain or sprocket with the correct size.
	Excessive load.	Reduce the load, add lubrication, or increase the number of strands or the size of the chain.
	Angle of chain wrap on the sprocket is insufficient.	Angle of chain wrap should be at least 120°.
	Elongation of the chain due to wear or excessively worn sprocket teeth.	Replace with new chain and sprockets.
Unusual noises	Improper installation of the sprocket or shaft.	Inspect and correct.
	Chain casing or bearings are loose.	Tighten all bolts and nuts.
	Excessive or insufficient slack in the chain.	Adjust the distance between the shafts to obtain the proper amount of slack or install a tensioner.
	Excessively worn chain or sprockets.	Replace with new chain or sprockets.
	Interference of casing with the chain or other moving parts.	Inspect and correct.
	Lack of or unsuitable lubrication.	Provide proper lubrication according to the operating conditions.
 <p>Excessive vibrations in chain</p>	Chain is resonating with periodic external force.	Change the chain's mode of vibration. <ol style="list-style-type: none"> 1. Preventing resonance. <ol style="list-style-type: none"> a. To change the natural frequency of the chain. <ul style="list-style-type: none"> - Alter the effective tension either by applying an initial tension or adjusting the existing one. - Install a tensioner to change the chain span. - Replace the chain. Choose a different quality and spring coefficient. b. Change the vibration frequency. <ul style="list-style-type: none"> - Change the speed of rotation of the sprocket. - Re-evaluate the device set-up. 2. Mechanically reducing the vibrations. <ul style="list-style-type: none"> - Install a Chain Guide - Install a self-adjusting tensioner on the slack side. 
	Load fluctuations are excessively large.	Reduce fluctuations with fluid coupling or similar technique.
 <p>Chain winds onto the sprocket (Poor separation from the sprocket teeth)</p>	Span between shafts is too large.	Install an idler.
	Excessive slack in chain.	Adjust the chain length or the distance between shafts. Or install a tensioner.
	Elongation of the chain due to chain wear or excessively worn sprocket teeth.	Replace with new chain and sprocket.

11. ROLLER CHAIN TROUBLESHOOTING AND PROBLEM SOLVING

Symptom	Possible Causes	Solution
Rusting of the chain	Inappropriate selection of material.	Select a more suitable chain material.
	Improper lubrication or poor environment.	Replace chain and protect the chain from the environment by appropriate lubrication and/or a cover.
Excessive wear on the inside surface of the link plates and sides of the sprocket teeth	Improper installation 	Correct sprocket and shaft installation.
Excessive wear on the outside surface of the link plates and pin heads	Improper installation of guides, etc. 	Check the condition of the guides, and increase the gap between the guides and the chain.
 Poor articulation	Chain is not installed correctly.	Inspect installation and correct as necessary.
	Chain and sprocket do not match.	Replace chain or sprocket.
	Contamination from metal dust or dirt because of improper lubrication.	Remove the chain, wash it thoroughly, and provide proper lubrication.
	Excessive load (causing bent pin, or cracked bush)	Reduce the load, increase the number of chain strands or the size of the chain.
	Corrosion.	Install a chain casing to protect the chain. Select a suitable chain.
	Seizing of pin and bush. 	Select proper chain size. Provide adequate lubrication method.
Highspeed operation.	Reduce the speed or select a more suitable chain.	
Spreading of link plates.	Uneven or excessive loading caused by improper installation. 	Replace with new chain and correct installation.

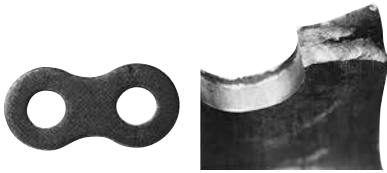
11. ROLLER CHAIN TROUBLESHOOTING AND PROBLEM SOLVING

11.2 Link Plate Related

 <p>Static Fracture Stretching the link plate with a tensile load beyond its breaking load will cause it to stretch and then break.</p>	 <p>Fatigue Fracture By repeatedly applying a load past its fatigue limit (fatigue strength), the fatigue will start at holes and then suddenly break.</p>	 <p>Offset Link Plate Fatigue Offset link plates are bent at the center, and the resulting concentration of stress at the bend can cause a fatigue break. Avoid using offset links in high-stress applications.</p>
Symptom	Possible Causes	Solution
<p>Static Fracture Breakage of link plate.</p>	Excessive large shock load.	Reduce shock loads by making the start-up, stopping, and other actions smoother (install a shock absorber). Increase the number of strands or the size of the chain.
	Vibration.	Install an anti-vibration device such as a tensioner or idler.
	Large inertia in the driven machine. (excessive load).	Increase the number of strands or the size of the chain.
	Corrosion.	Install a chain casing to protect the chain. Select a suitable chain.
<p>Fatigue Fracture Breakage of link plate.</p> 	Loads are greater than maximum allowable load.	Reduce the load, increase the number of chain strands or the size of the chain.
<p>Deformation of link plate holes.</p> 	Excessive load.	Reduce the load, increase the number of chain strands or the size of the chain.
<p>Corrosion stress cracks appear, usually as bow-shaped cracks in the link plate.</p> 	The chain is being used in an acidic or alkaline environment.	Install a chain casing to protect the chain. Select a suitable chain. (Please consult Tsubaki.)

11. ROLLER CHAIN TROUBLESHOOTING AND PROBLEM SOLVING

11.3 Pin Related



Static Fracture

The type of fracture found when subjecting the chain to the breakage test. Occurs when chain is subjected to a load greater than its breakage strength.



Fatigue Fracture

Occurs when the pin is repetitively subjected to loads greater than its fatigue limit.



Shock-induced Bending Fracture

The pin is subjected to a large shock load and breaks. The side with the initiating point receives tensile load, and the fracture progresses from this point. A pin is especially susceptible to becoming weak with regard to bending when the surface of the pin has corroded. This type of phenomenon occurs quite easily.

Symptom	Possible Causes	Solution
Breakage of pin.	Excessive large shock load.	Reduce shock loads by making the start-up, stopping, and other actions smoother (install a shock absorber). Increase the number of strands or the size of the chain.
	Loads are greater than maximum allowable load.	Reduce the load, increase the number of chain strands or the size of the chain.
	Corrosion.	Install a chain casing to protect the chain. Select a suitable chain.
Pin rotates or begins to stick out.	Excessive load.	Replace chain immediately. Reduce the load, increase the number of chain strands or the size of the chain.
	Operating a chain with high load without proper lubrication can create friction between the pin and bush, causing the pin to rotate.	Replace chain immediately. Provide proper lubrication according to the operating conditions.
Wear or rust occurs only at the connecting pin.	Improper initial lubrication at installation.	Replace the connecting link. Provide proper lubrication.

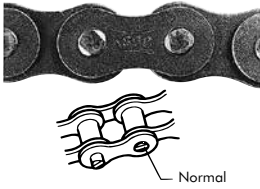

11. ROLLER CHAIN TROUBLESHOOTING AND PROBLEM SOLVING

11.4 Bush / Roller Related



Fatigue fracture

Occurs when the Roller and/or Bush is repetitively subjected to loads greater than its fatigue limit. Impact with the sprocket teeth at a force exceeding the chain's transmission capacity.

Symptom	Possible Causes	Solution
Roller and/or bush splits in two pieces.	Excessive load.	Reduce the load, increase the number of chain strands or the size of the chain.
	Inadequate lubrication.	Provide adequate lubrication.
	Too few teeth with respect to the speed.	Increase the number of teeth or decrease the speed.
Improper roller rotation and uneven roller wear.	The inner link plate is forced inwards.	Re-inspect the installation and load conditions.
	Bush is cracked.	Re-inspect the installation and load conditions.
	Foreign particles stuck between the bush and roller.	Periodically clean the chain. Install a casing to protect the chain.
Roller is opening up.	Excessive load. 	Reduce the load. Provide adequate lubrication.
Roller is becoming hourglass shaped.	Excessive load or inadequate lubrication.	Replace with new chain. Improve the lubrication or loading conditions.

1. INTRODUCTION TO TSUBAKI ATTACHMENT CHAIN

In the world of attachment chain TSUBAKI is the manufacturer you require to assure smooth operation. Whether your application requires attachments or extended pins in Carbon Steel, N.E.P., Nickel Plating or Stainless Steel, TSUBAKI is your partner. TSUBAKI's maintenance free solution, LAMBDA, is also available with a wide range of attachments. When starting with a completely new design, TSUBAKI can tailor make an attachment chain for you in any specification.

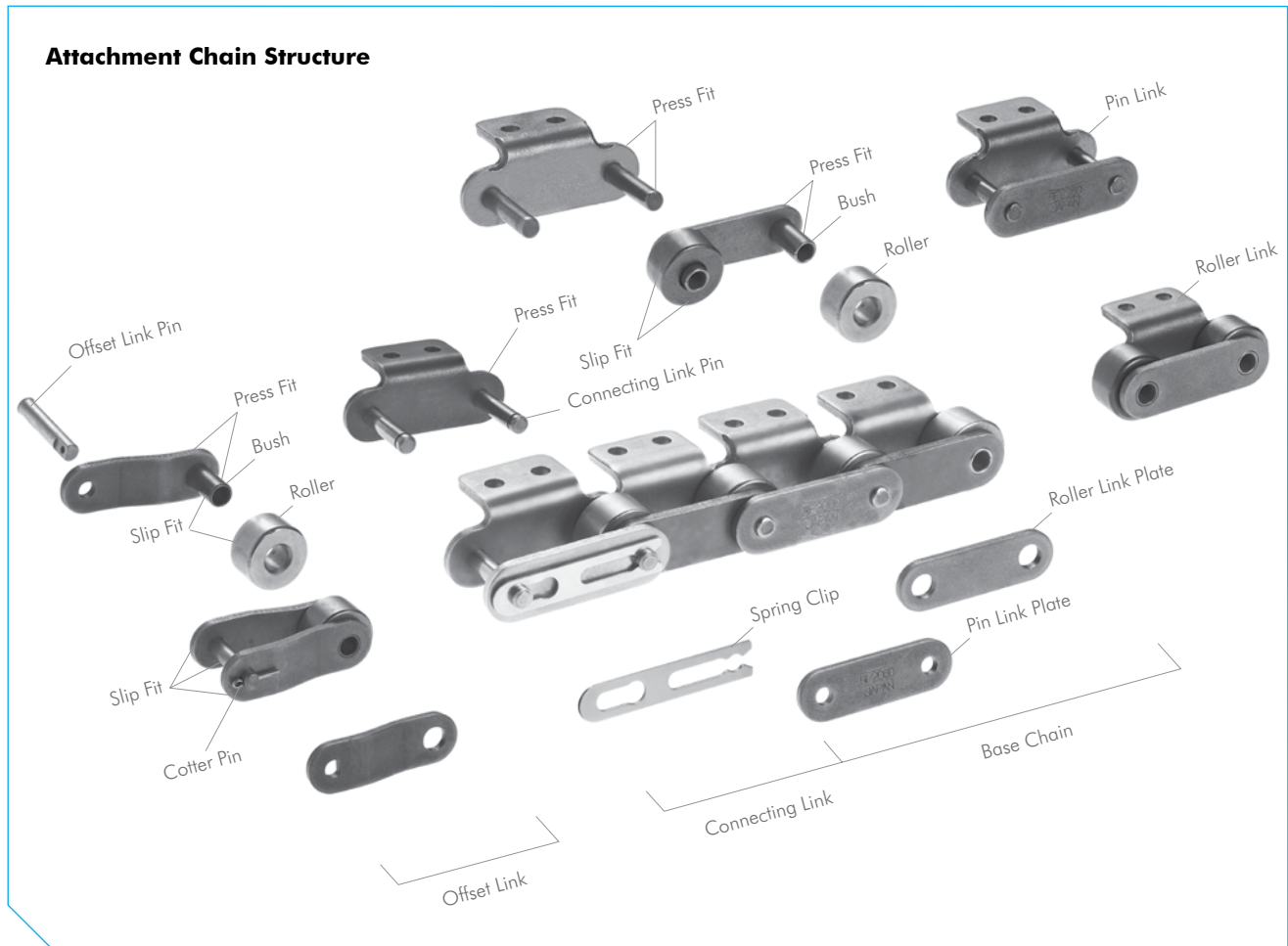

Attachment Chain Structure

There are mainly two types of Attachment Chain: Single Pitch and Double Pitch.

1. Single Pitch Attachment Chain

Single pitch attachment chains are based on roller chains with attachments added to make them suitable for conveying use. Due to the smaller chain pitch, this type of chain is ideal for short centre distances, and the conveying of small and light goods. Single pitch attachment chain has smooth transfer and low noise characteristics and can be used at relatively medium conveying speeds. Standard roller chain sprockets can be used in most cases.



Single Pitch Attachment Chain

1. INTRODUCTION TO TSUBAKI ATTACHMENT CHAIN

2. Double Pitch Attachment Chain

This is the most commonly used attachment chain and is utilised widely in the automotive parts, electric, electronic, and precision machinery industries. Double pitch roller chain has the same basic construction as single pitch roller chain, but has twice the pitch length. A major benefit is that whilst larger conveyor lengths are possible, a double pitch chain uses only half the components of a single pitch chain in the same application, resulting in less components to wear.

The choice of sprockets depends on the roller type applied to the chain. Chain with S-type rollers can be driven by standard roller chain sprockets (> 30 teeth). The chain engages every second tooth. Special sprockets are needed when R-type rollers are used.



Double Pitch Attachment Chain

3. Three Basic Dimensions

Pitch, Roller Diameter and Inner Width are known as the “Three Basic Dimensions of Roller Chain.” When these three dimensions are identical to the existing chain being replaced, then the roller chain and sprockets are dimensionally compatible. With attachment chain a lot of additional dimensions are important to ensure a safe replacement and carefree installation of the chain. Please refer to our dimension tables for the appropriate dimensions.

4. Basic Parts

Link Plate

The link plate is the component that bears the tension placed on the chain. Usually this is a repeated load, sometimes accompanied by shock. Therefore, the plate must not only have great static tensile strength, it must also hold up to the dynamic forces of load and shock.

Pin

The pin is subject to shearing and bending forces transmitted by the plate. At the same time, it forms a load-bearing part (together with the bush) when the chain flexes during sprocket engagement. Therefore, the pin needs high tensile and shear strength, resistance to bending, and must also have sufficient endurance against shock and wear.

Bush

The bush is subject to complex forces from all parts, especially from the repetition of shock loads when the chain engages with the sprocket. Therefore, the bush needs extremely high shock resistance. In addition, the bush forms a load-bearing part together with the pin and as such requires great wear resistance.

Roller

The roller is subject to impact load as it mates with the sprocket tooth during engagement of the chain with the sprocket. After engagement, the roller changes its point of contact and balance. It is held between the sprocket tooth and bush, and moves on the tooth face whilst receiving a compression load. Therefore, it must be resistant to wear and still have strength against shock, fatigue and compression.

There are two types of rollers for Double Pitch Attachment chain: S-roller (standard) and R-roller (oversized). The S-rollers are used in short-length and slow-speed conveying. The R-rollers are most commonly used for longer conveying applications. (RS35 is a bush chain and does not have rollers).

Roller Link

Two bushes are press fit into two roller link plates and rollers are inserted to allow rotation around the outside of the bushes during operation. This is the same for single and for multi strand chains.

Pin Link

The pin link consists of two pins that have been press fit into two pin link plates.

Spring Clip and Cotter Pin

The spring clip prevent the link plate from becoming detached, with the cotter pin type being as an added security measure where there is as possibly of the clip being removed due to interference from chain guides or some other aspect of the application.

5. Assembly Parts

Roller chains are usually made up of a number of inner and outer links in an endless formation. Although offset links can be used when there is an odd number of links in the roller chain, it is better to use a design that requires an even number of links, thus eliminating the use of offset links.

Connecting Links

There are two types of connecting link: spring clip connecting link and cotter pin connecting link. It's common to use slip fit spring clip connecting links for small size attachment chains. Cotter pin connecting links are used for large size attachment chains and on customer request.

Offset Links (OL)

An offset link is used when an odd number of chain links is required. The pin and two plates are slip fit. The fatigue strength is 35% (applicable to ANSI chain) lower than that of the chain itself.

1. INTRODUCTION TO TSUBAKI ATTACHMENT CHAIN

Overview Single Pitch Attachment Types

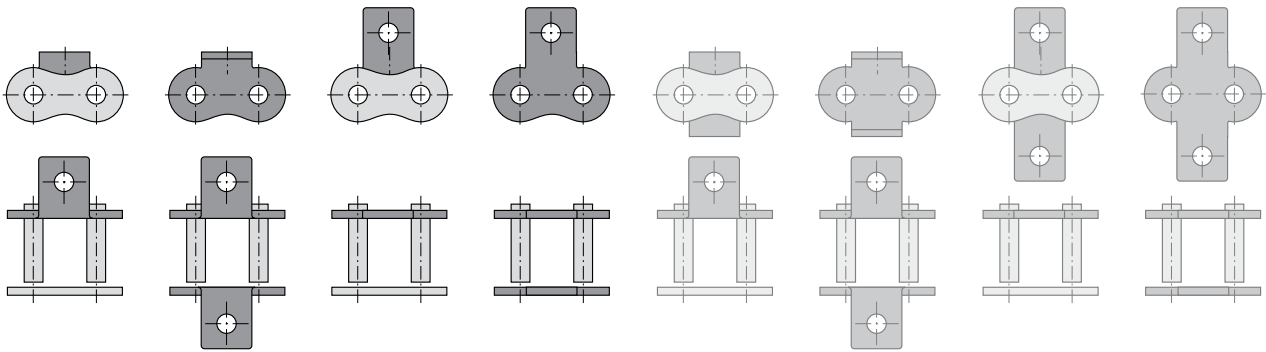

A-1

K-1

SA-1

SK-1

AA-1

KK-1

SAA-1

SKK-1

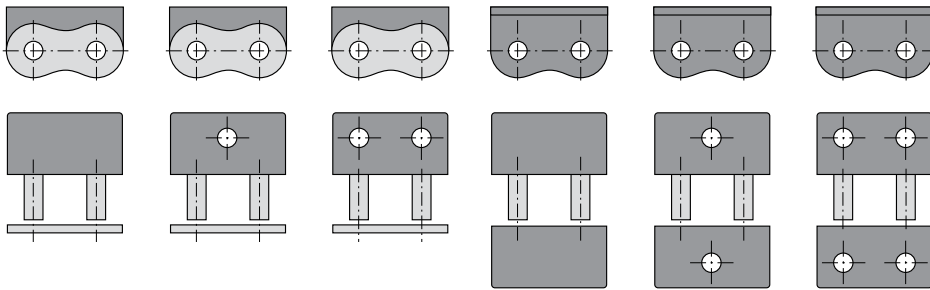

WA-0

WA-1

WA-2

WK-0

WK-1

WK-2

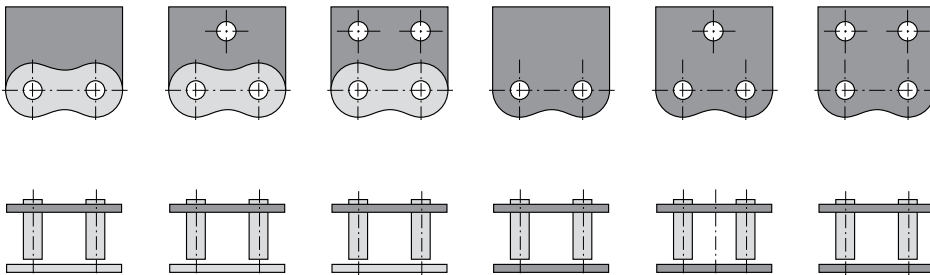

WSA-0

WSA-1

WSA-2

WSK-0

WSK-1

WSK-2

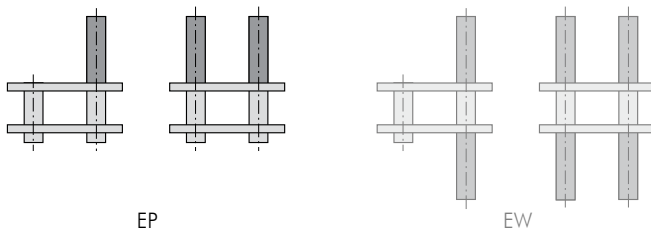

EP

EW

Extended Pin

1. INTRODUCTION TO TSUBAKI ATTACHMENT CHAIN

Overview Double Pitch Attachment Types

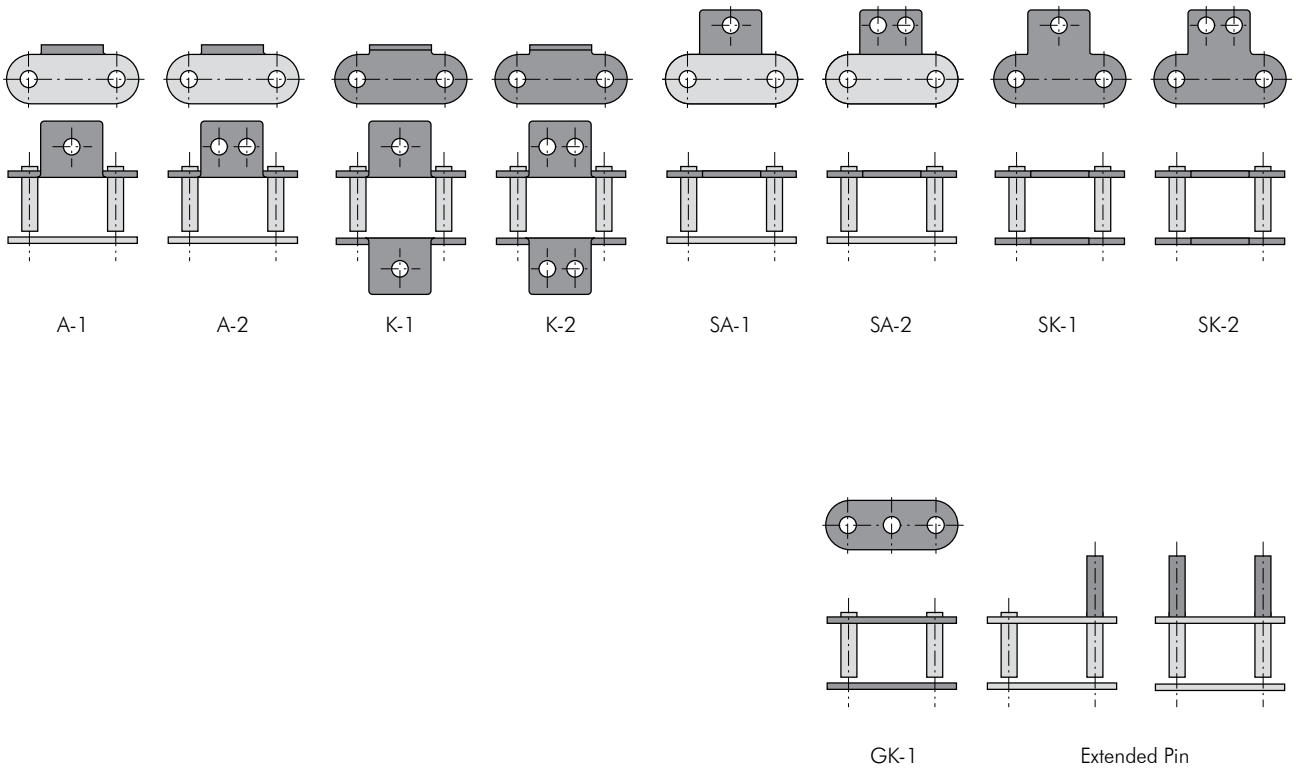

1. INTRODUCTION TO TSUBAKI ATTACHMENT CHAIN

Chain Types

In addition to standard single and double pitch attachment chain, two other chain types are commonly used for conveyance purposes:

Hollow Pin Chain (HP)

This particular design of chain has a hollow bearing pin allowing for the installation of various attachments. Usually these chains are used for conveyors. The advantages of installing attachments into the hollow pin include the following:

- The hollow pin is at the centre of articulation, and always keeps the pitch length. Regardless of whether the chain is straight or wrapping around the sprocket, the centre distance of attachments is always the same.
- With a cross rod over two chains, the load from the attachments is distributed equally between the link plates. The chain can fully utilise its strength and will not twist.
- It is easy to change, maintain, and adjust attachments.
- Standard sprockets are used for the single pitch series. For double pitch series, standard sprockets for double pitch roller chain are used.



Hollow Pin Chain

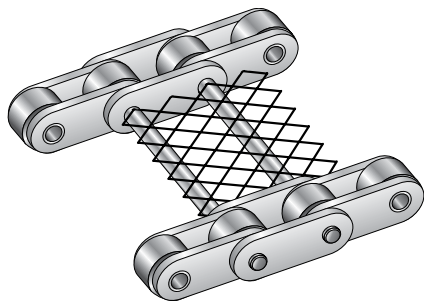

Cross Rods with Mesh

Curved Chain (CU)

Due to TSUBAKI's exclusive pin and bush structure and the wide plate to plate clearance, this roller chain has a large side flex radius. The basic dimensions of this chain are the same as ANSI standard roller chain. The ability to use ANSI standard sprockets makes curved transmission simple. Guides are required for all curved areas.

Attachments

The characteristics of the conveyed materials and the working environment are different for each application. Many types of attachments are available with or without jigs.

Our standard attachments are available based upon the long history of attachment chain usage and demand. Being high quality,

economical with a quick delivery to meet customers' requirements.

- For Single Pitch attachment chain, standard attachments include: A, WA, K, WK, SA, WSA, SK, WSK and Extended Pin types.
- For Double Pitch attachment chain, standard attachments include: A, K, SA, SK, GK-1 and Extended Pin types.

On pages 38 and 39 an overview of the most common attachment types can be found.

Standard attachments are available for a wide variety of chains:

- With special surface treatments (N.E.P. or Nickel-Plated).
- Made of 304 stainless steel or other materials.
- For lube-free operations (LAMBDA and PC series, etc.).

W-Designation

Attachments with W-designation only differ in the width of the bent or extended part of the link plate. The width of W-attachments is equal to the width of the link plate.

The W-type option is only applicable on the four standard attachments: A, K, SA and SK (referenced WA, WK, WSA and WSK respectively).

There are no W-type attachments available for double pitch attachment chains.

A Attachment

An A attachment is the most commonly used. It has a bent link plate that extends out on one side of the chain, forming an L-shape. It comes with one or two bolt holes, referred to as A-1 or A-2. The attachment interval can vary (for example, on each chain link, every five links, or two attachments in a series with intervals every four links, etc.). Generally two strands of chain are used in parallel with slats.



A-1 Attachment

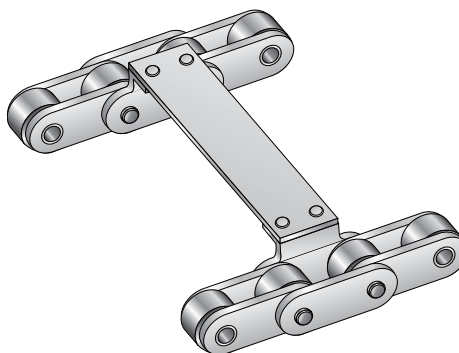

A-2 Attachment with Slot

The attachments are subject to bending force. If they convey heavy objects, have long jigs installed, or receive side loads,

1. INTRODUCTION TO TSUBAKI ATTACHMENT CHAIN

twisting force is added to the bending force. Depending on the application, please ensure you consider these forces in your calculations.

The shape of the attachment influences the design of the equipment. If slats do not cover the chain rollers, guide rails may be used to support the chain rollers on the return side.

K Attachment

This is an attachment made by installing A attachments on both sides of the chain. The attachment is called K-1 or K-2 based on the number of bolt holes on each individual attachment. The attachment interval can vary, same as the A attachment.



K-1 Attachment

The top of the attachment is higher than the R-rollers, so slats or jigs can be installed over the chains. Objects can also be conveyed directly on the K attachments.

When a wide slat is installed on two A attachment chains, the slats may not be able to support the weight. A chain with K attachments is installed between the A attachment chains to help support the load.

When the slats are rigid enough and are fastened well to the attachments, there is almost no effect from bending force to the strength of the attachment. But if the slat is not fastened well, make sure to consider the bending force in your calculation.

If long jigs are installed, or the attachment receives side loads, it will be exposed to twisting forces.

The return side of the K attachment chain cannot be supported with guide rails on the rollers. The return may be slack or supported in some other way.

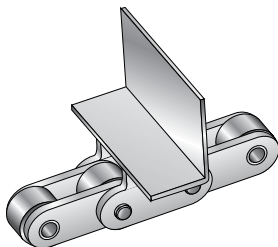

K Attachment with L-angle

SA Attachment

For the SA attachment, the link plate is extended on one side of the chain, and one or two bolt holes are installed. These are called SA-1 or SA-2 depending on the number of the bolt holes. The attachment interval can vary the same as the A attachment. These attachments may be adapted for use with hooks or slats. The SA attachment is simpler and stronger than the A attachment, and may receive bending and twisting force depending on the direction of the loads.

The return side of the chains can be supported by guide rails on the rollers unless bolts extend into the attachment.



SA-1 Attachment

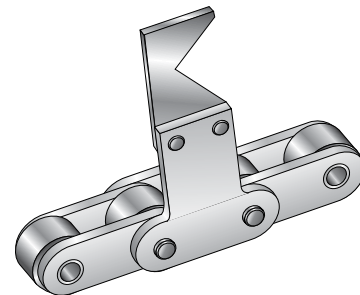

SA-2 Attachments with Hook

SK Attachment

SK attachments are made by installing SA attachments on both sides of the chain. They are called SK-1 or SK-2, depending on the number of bolt holes on each individual attachment. The attachment interval can vary the same as the A attachment.

Usually SK attachments are used with dogs or jigs. SK attachments are strong enough to withstand bending or twisting forces.

The return side of SK attachment chains cannot be supported by guide rails on the rollers as can A or SA attachment chains. The return must be slack or supported in some other manner.



SK-1 Attachments

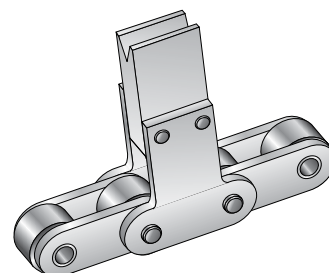

SK-2 Attachments with V-block

1. INTRODUCTION TO TSUBAKI ATTACHMENT CHAIN

Extended Pin Attachment

In this form, one end of the pin is extended. The attachment interval can vary the same as the A attachment.

As shown in below figure, two sets of D attachment chains can be connected to cross rods, or jigs (such as blocks).

The extended pins are subjected to bending and shearing forces. The return side of the D attachment chain can be supported by guide rails on the rollers.



Extended Pin Attachment

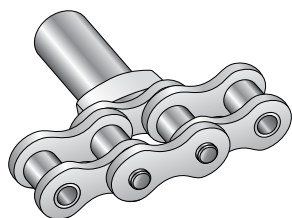

D Attachments with Jigs

GK-1 Attachment

A hole is added to the centre of both link plates, to be able to attach cross rods between two (or more) parallel running chains. The attachment interval can vary the same as the A attachment. This type of attachment is often used when cross rods with larger diameters than the maximum applicable diameters of hollow pin chains are used. This type of attachment is only available as a double pitch attachment chain, Type R-rollers can not be used in combination with GK-1 attachments due to the interference between the roller and the hole in the link plates.



GK-1 Attachment

Chain Length Tolerance

Maintaining an accurate overall length tolerance in attachment chain is essential for conveying and index drive equipment used in such applications as inserting components, product assembly lines, integrated circuit boards and board/paper & packaging amongst many others.

The tolerance of the overall chain length is depending on the chain type and the appropriate international standard:

Single Pitch Chain

- BS Single Pitch Roller Chain
According to ISO 606: 0% to +0.15%
- BS Single Pitch Attachment Chain
According to ISO 606: 0% to +0.30%
- ANSI Single Pitch Roller Chain
According to ANSI: 0% to +0.15%
- ANSI Single Pitch Attachment Chain
According to ANSI: 0% to 0.30%

Double Pitch Chain

- ANSI Double Pitch Roller Chain
According to ANSI: 0% to 0.13%
- ANSI Double Pitch Attachment Chain
According to ANSI: 0% to 0.25%

TSUBAKI chain length tolerances are very narrow by nature, however some markets require narrow tolerance chain; in the market often referred to, and marketed as 1/3 DIN or 1/6 DIN length tolerance chain. TSUBAKI chain coming from the same production lot is generally complying with these tolerances as a standard; once again our constant high quality.

As shown in below figure the amount of variation for several types of chain chosen at random from the same production run.

Chain Length [mm]	Matched Tolerance [mm]
< 14 m	< 3 mm
14~30 m	< 4 mm
30~44 m	< 5 mm

Attachment Chains Chosen at Random from Same Production Lot

When even more accurate tolerances are required, TSUBAKI can offer an effective solution with the Match & Tag Service. This can be useful for attachment chains which have to run parallel in pairs and where a minimum of chain length tolerance is required.

Match & Tag Service: High Accuracy, Narrow Tolerance Service

For TSUBAKI; quality is second nature- and so for customers with specific application requirements, we are able to supply chains with a specific length tolerance, or even pairs & multiple chains length matched and tagged in the same way for easy identification and installation. This is as a result of the sophisticated chain length measurement equipment (the "Matchy") kept in house within the European headquarters with supply times for such chains kept to a minimum-ideal for distributors, final consumers and OEM customers alike.

Sizes

The Matchy at our European Headquarters is equipped for:

- BS Single Pitch sizes RS08B to RS32B
- ANSI Single Pitch sizes RS40 to RS100 (including Heavy Duty Series)
- ANSI Double Pitch sizes RF2040 to RF2100

For other sizes and specific demands please contact TSUBAKI, our Engineering Department will explain all options available.

Tolerances

When chains have to run in parallel for conveying purposes in for instance packaging machines or when a minimum of difference

1. INTRODUCTION TO TSUBAKI ATTACHMENT CHAIN

in chain length is required in lifting applications (accumulator towers in the steel and carpet industry) TSUBAKI excels in quality performance. We can guarantee a maximum chain length difference of 0.50 mm independent of the total chain length demanded by our customers!

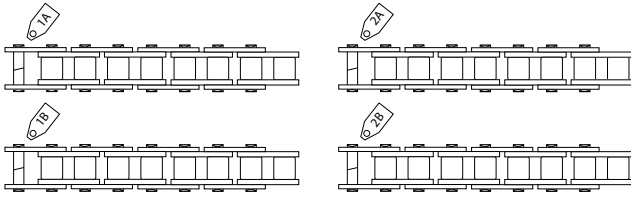

Tagging of Matched Chain Strands

Local Assembly Service

TSUBAKI offers a huge range of attachment chains to suit virtually any application.

An extended range of stock components covering the majority of standard applications, and a built to order service using more specialised attachments also held in stock within Tsubakimoto Europe-swift deliveries can be both achieved...and maintained. Along with the Made To Order service when very unusual or highly specialist solutions can be delivered on accurate lead times from TSUBAKI's dedicated state of the art factory results in a comprehensive supply chain capability.

As our customers increase production capacity and reduce maintenance windows, we believe that this high level of product availability and swift delivery can make a difference. This policy represents TSUBAKI's core values.

If a standard attachment chain is required (for volumes typically under 50 meters) it can be assembled from stock lengths and/or components. If an attachment is required with a specific dimension requirement such as a non standard assembly hole then the attachment can be produced within Europe.



Matching Chain Strands



Local Assembly Service

2. ORDERING TSUBAKI ATTACHMENT CHAIN

When ordering TSUBAKI attachment chain, please specify the chain size and material as well as the chain length, installation position and configuration of attachments.

2.1 Chain Identification

For product codes and chain identification, see the model identification examples below and dimension tables in catalogue 2 Attachment Chain.

BS Attachment Chain identification examples:

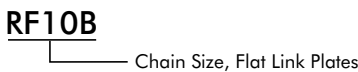
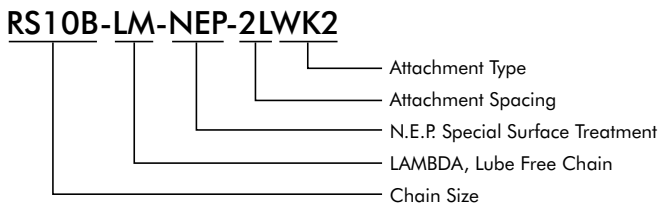
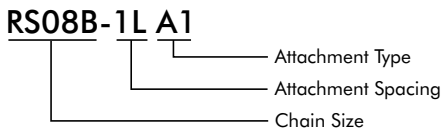

ANSI Attachment Chain identification examples:

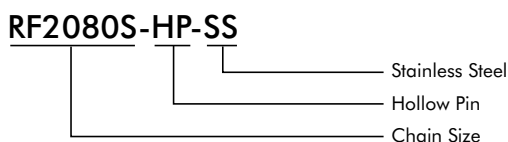
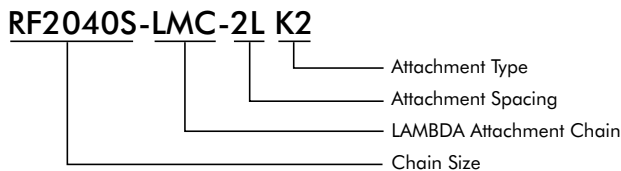
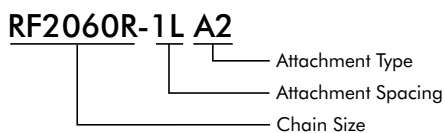
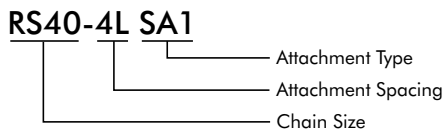

2.2 Specific Ordering Procedure for Attachment Chain

a) Standard Chain Units (Stock Items) [1 unit = 10 ft/3,05 m]

- Small size conveyor chain with attachments is stocked in units (standard length). Each unit consists of an even number of links
- A connecting link is supplied on one end of each chain unit; an inner link is supplied on the other end. In general, these terminating links can be joined together to make a longer chain.
- When splitting a standard unit, order the additional required number of connecting links separately.

Example: **RF2040R-4LA2** n units
RF2040-A2-CL n pieces

b) Special Assembly (Made To Order) Chain

A chain assembled to your specifications regarding chain length, termination on both ends, attachment spacing etc., is called a "special assembly". How to specify the formation is described below.

(1) When total length is an even number of links

- A connecting link is supplied on one end of each chain unit; an inner link is supplied on the other end.
- Specify the position and spacing of attachments according to the examples shown in the "Attachment Spacing and Description" table on page 46 and 47.
- Please contact a Tsubakimoto representative for special chain lengths.

2. ORDERING TSUBAKI ATTACHMENT CHAIN

- (2) When total length is an odd number of links (please refer to the pictures on page 12)
- Specify how both ends should be terminated:
 - a) Inner links on both ends
 - b) Connecting links on both ends
 - c) Outer links on both ends (shipped with the outer links disassembled; after assembling the outer links on both ends, the end surfaces of the pins must be properly secured by riveting)
 - d) Connecting link on one end and offset link on other end

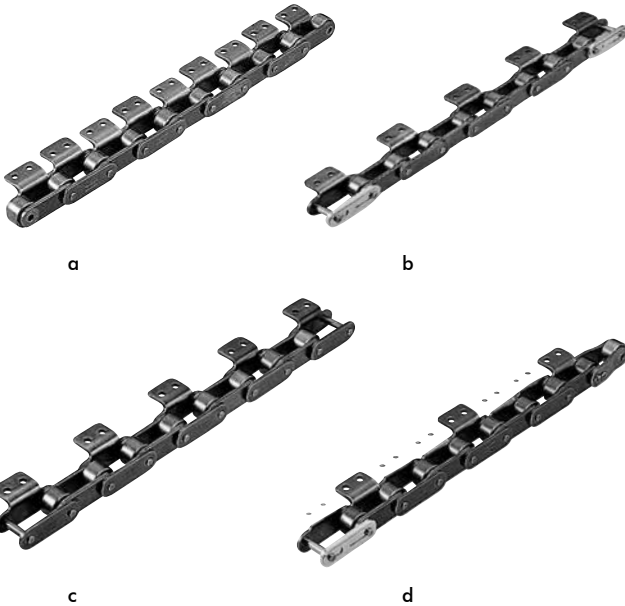

- Specify the position and spacing of attachments according to the examples shown in the "Attachment Spacing and Description" table on page 46 and 47.
- Please contact a Tsubakimoto representative for special chain lengths.

- (3) When chains are to be used as strands
- Mirror-image strands in pairs

Attachments on a set of chains to be used as strands are manufactured to be symmetrical (see illustration below)

Specification example:
RF2040S-6LA1-5L EP 6 units

Strand specs: 120 links by 6 strands
(120 links x 2 strands x 3 sets)

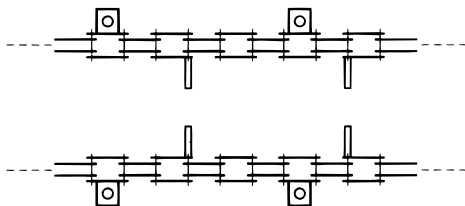

Mirror-image strands in pairs
Attachments are mirror images on opposite strands

- Matched and tagged in pairs

Chain lengths will vary within standard tolerance. When it is desirable to minimize the relative difference in total chain length in a set of chains to be used as strands, the chain is matched and tagged in pairs.

Specification example:
RF2040R-2LA2 6 units
Strand specs: 2 strands x 3 sets
Matched and tagged in pairs

Note: There is an extra charge for chains matched and tagged in pairs. Please inquire for an estimate.

- (4) Long chain lengths (long configurations)
- Chains consisting of more than one unit are called "long chains." There are limitations on total chain length depending on chain size and conveyor type. Please inquire for details.

2.3 Configurations When Ordering by Total Number of Links

- a) For long configurations, be sure to specify [see b-(4) above]
- b) When unspecified:
- (1) We will ship n units, plus one unit having a fractional number of links.
However, when the fractional number of links is less than one-fourth of a unit, we will ship only one long configuration chain consisting of one unit plus a fractional number of links.

Example:
RF2040R-2LA2 380 links
Shipping form:
120 links (length of one unit) 2 strands
140 links 1 strand

- (2) When a single unit cannot be split at an interval between attachments, we will determine a configuration (length) using a number of links that enables the chain to be split in the range of (1 unit – 1/4 unit). The fractional number of links will be treated in the same way as above.

2. ATTACHMENT SPACING AND DESCRIPTION

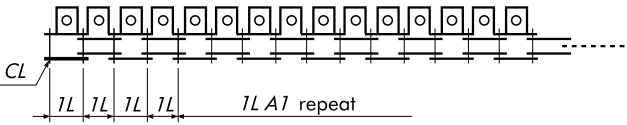
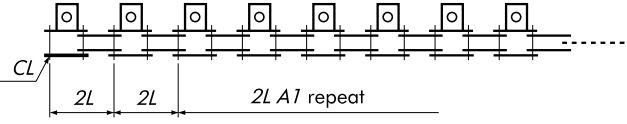
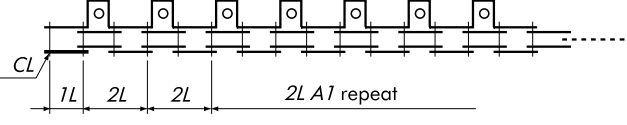
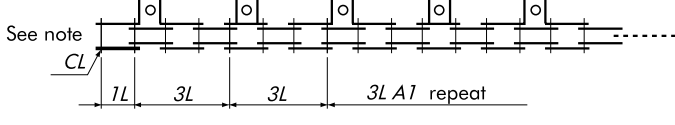
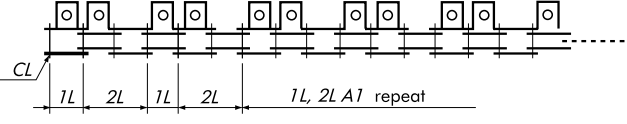
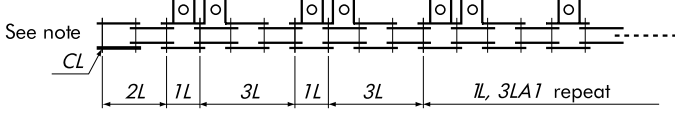
Chain Numbering Example	Connecting Link (CL) Type	Attachment Formation
08B-1LA1	A1-CL	
08B-2LA1	A1-CL	
08B-2LA1RL	Plain CL	
08B-3LA1	Plain CL	
08B-1L2LA1	A1-CL	
08B-1L3LA1	Plain CL	

2. ATTACHMENT SPACING AND DESCRIPTION

Chain Numbering Example	Connecting Link (CL) Type	Attachment Formation
08B-2L4LA1	Plain CL	<p>See note</p> <p style="text-align: center;"> $2L$ $2L$ $4L$ $2L, 4LA1$ repeat </p>
08B-2L2L4LA1	Plain CL	<p>See note</p> <p style="text-align: center;"> $2L$ $2L$ $4L$ $2L, 2L, 4LA1$ repeat </p>
08B-2L3L5A1	Plain CL	<p>See note</p> <p style="text-align: center;"> $2L$ $2L$ $3L$ $5L$ $10L$ $2L, 3L, 5LA1$ repeat </p>
08B-2LEP	EP-CL	<p style="text-align: center;"> $2L$ $2L$ $2L$ $2L$ EP repeat </p>
08B-1L3LEP	Plain CL	<p>See note</p> <p style="text-align: center;"> $2L$ $1L$ $3L$ $1L$ $3L$ $1L, 3L$ EP repeat </p>

3. CUTTING TSUBAKI ATTACHMENT CHAIN

If the chain you purchased is either a standard length or on a reel, you need to cut the chain to the necessary length. There are two relatively simple methods for disconnecting (cutting) attachment chain. One way is to use a chain vice and punch. The other is to use a chain breaker.

Attachment chains are generally sold in 1-unit sections (1 unit = 10 feet = 3.05 meter).
Configuring chain to a specific length will require cutting units.

3.1 Grinding Riveted Pin

Using a grinder, grind down the ends of the two pins on the outer link (on the attachment side) until they are level with the outer plate. Take care that the grinder does not overheat. Particularly in the case of Lambda Chain, work on the chain slowly so that the oil-impregnated bush does not become too hot.

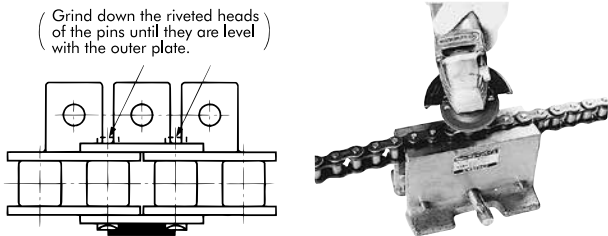

Attachment chain

Grinding down pin ends

3.2 Setting Chain in Vice and Cradle

1) S roller (A, SA attachments)

Place the chain in the jaws of the vise with the attachment side facing up and gently tighten the vise to secure the chain.

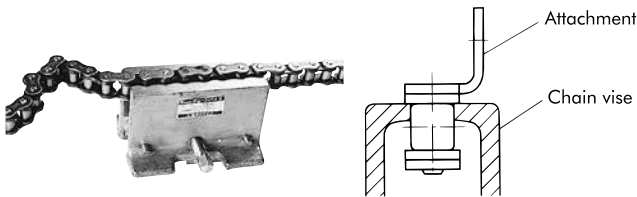

Setting chain in chain vise

Cross section of chain set in chain vise

2) S roller (K, SK attachments), R roller (K, SK attachments), plastic R roller, Poly Steel Chain (with attachments)

For these types, the chain is set in a cradle.

Another method, used only for steel S rollers, is to set the pin to be removed on the edge of the chain vise.

Whichever method is used, support blocks should be placed under the chain on either side of the vise to ensure that the chain remains stable. Any attachment can be cut using this method. However more force will be required to remove the pin as mentioned in "3.3 Pin Removal"

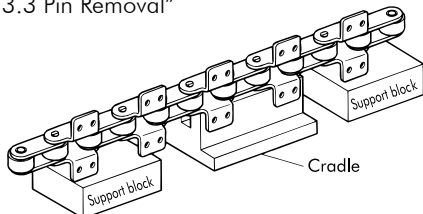

Cradle and support blocks

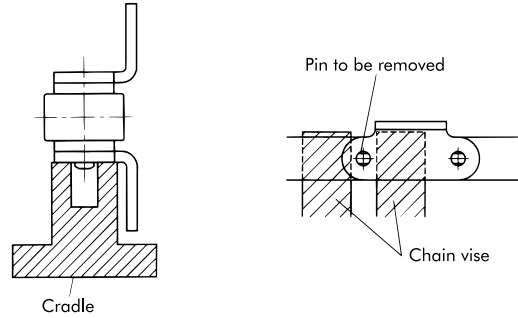

Cradle cross section

Chain vise usage

3) R roller (A, SA attachments)

This method cannot be used for plastic rollers.

Secure the non-attachment side plate of the chain in the vise and support the R rollers on the vise. Ensure that the chain is supported on both sides of the vise.

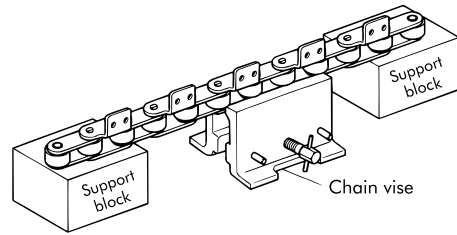

Chain vise and support blocks

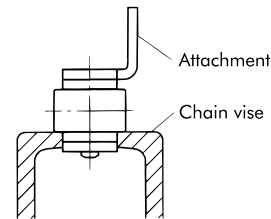

Cross section of chain set in chain vise

3.3 Pin Removal

1) Using a primary punch suitable for the chain size, place the punch on the head of the pin that was ground down and strike with a hammer. Be sure to strike the pins on the outer link alternately to remove them evenly and at the same time. Strike the pins until they are just about to release from the outer plate.

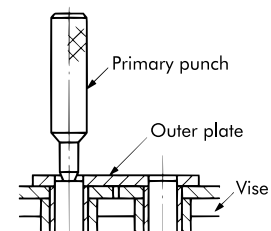

Tapping pin with primary punch

3. CUTTING TSUBAKI ATTACHMENT CHAIN

- 2) Using a secondary punch (refer to page 78 for chain cutting tools) and a hammer, completely remove the pair of pins from the outer link. Check that the bush of the removed pin has not come loose from the inner plate, and that the bush has not become deformed in the process. If the bush has come loose or is deformed, do not continue to use it.

3.4 Cutting Poly Steel Chain (Without Attachments)

- 1) Place the outer plate of the chain in the cradle, position the special punch on the head of the pin, and lightly strike with a hammer.
- 2) Work carefully, as there is a risk of damage if excessive force is applied to engineering plastic components in this process.

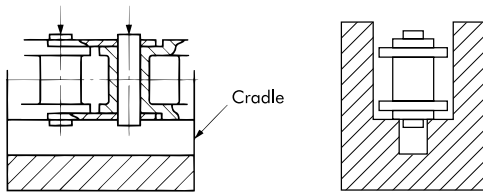

Cross section showing Poly Steel Chain set in cradle

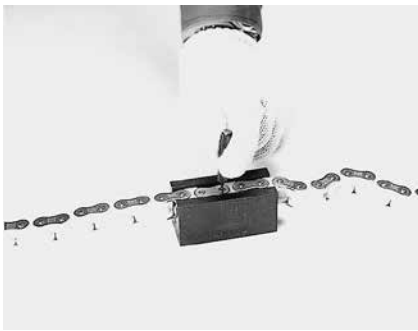

Disconnecting Poly Steel Chain

Safety Points

1. Use the grinder to grind down only the riveted portion of the pin head. Removing the pin without grinding the riveted head off will require additional time and effort, and may damage the chain.
2. Do not re-use parts removed from the chain.

3.5 Cutting Double Plus Chain

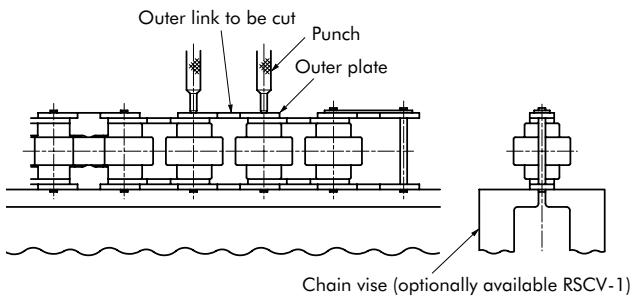

- (1) Shear off the rivet on the pin end of the outer link to be cut using a hand grinder.
- (2) Set the Double Plus Chain (for chain with snap cover, remove the snap covers from about three links of the area to be cut) on a chain vise (or its equivalent) and drive in the pin using a

punch or other means until the outer plate on the upper side is removed.

- (3) The chain can be cut by using a chain vise and a fork-shaped tool.

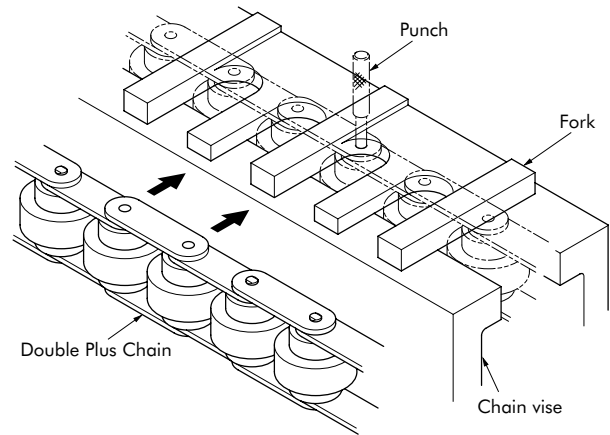

3.6 Cutting Outboard Roller Chain

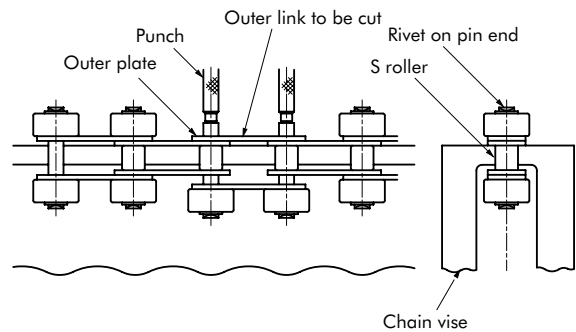

- 1) Cutting chain when the base chain roller is an S roller
 - a. Determine the outer link to be cut and mark the link for identification.
 - b. Set the chain on a chain vise (sold separately) as shown above and shear off the rivets on the pin ends (two rivets on one side) using a hand grinder.
 - c. Remove the two pins using a pin with a diameter slightly smaller than the pin diameter of the chain (using a TSUBAKI Punch or its equivalent). When the pins are pulled out a little, the two outboard rollers on the upper side can be removed. (The diagram above shows the outboard rollers being removed.)
 - d. Directly tap the pin with a small hammer until the end of the pin reaches the upper face of the outer plate to remove. Tap the two pins alternately to ensure they come off evenly. Use caution not to damage the outboard rollers on the right and left.
 - e. Tap and pull out the two pins using a punch until the outer plate on the upper side can be removed.

3. CUTTING TSUBAKI ATTACHMENT CHAIN

2) Cutting chain when the base chain roller is an R roller

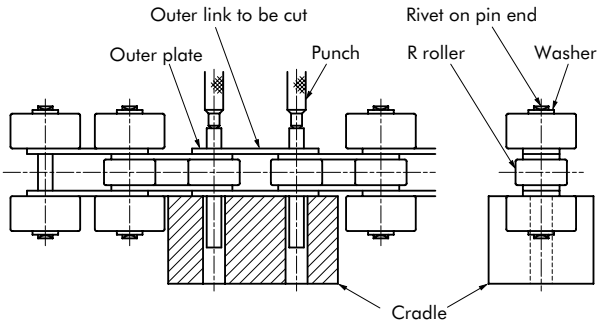

- Determine the outer link to be cut and mark the link for identification.
- Shear off the rivets on the pin ends (four rivets) using a hand grinder so as to remove the four outboard rollers. In doing so, shear down to the washers with the grinder to remove the washers.
- Remove the four outboard rollers. (Receive the outboard roller on the cradle, apply the punch on the pin end face, and tap the pin out until the washer is removed. Follow the same procedure to remove the washers on the other side.)
- Set the chain on the cradle as shown above and remove the two pins by tapping the punch with a hammer. Prepare a cradle yourself as appropriate.
- Follow steps d. and e. of 1).
- If outboard rollers are spaced every two or more links, the rivet parts to be sheared off will differ from those shown in the above diagram. (See the diagram below.)

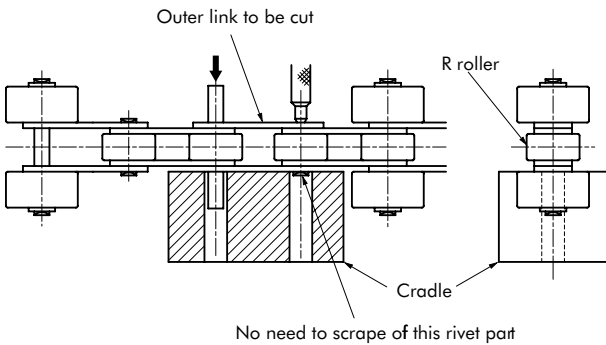

3) Cutting Poly Steel Chain with outboard rollers

- When the outboard rollers are arranged in a staggered installation

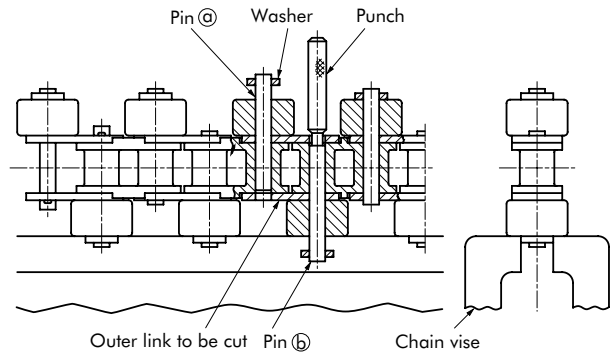

- Determine the outer link to be cut and mark the link for identification.
- Although the chain can be set in a chain vise in the same manner as shown in 1) (with S type), this setting damages the chain because the inner link is made of engineering plastic. For this reason this cutting method cannot be used.
- Lightly tighten the washer on the pin end with a chain vise. Since no rivet is provided on the pin end on this chain, proceed to cutting the chain.
- Use a pin with a diameter slightly smaller than the pin diameter of the chain (using a TSUBAKI Punch or its equivalent), tap the punch lightly with a hammer, and pull out the pin of the chain gradually (see the above diagram). When the pin is removed from the upper outer plate as shown above, stop tapping the pin.
- When pins a and b are pulled out in the same procedure, the chain can be cut. The diagram above shows the state whereby a pin has been pulled out to the specified position and pin b has already been pulled out.
- Discard the cut outer links (shown below).

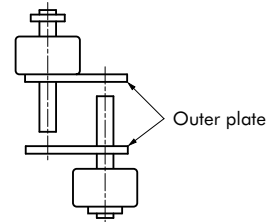

- When the outboard rollers are arranged in a crosswise installation

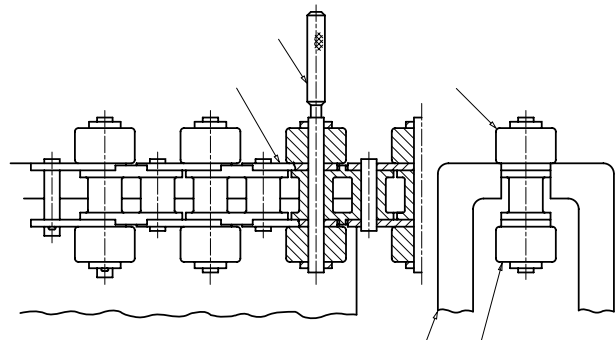

3. CUTTING TSUBAKI ATTACHMENT CHAIN

- Determine the outer link to be cut and mark the link for identification.
- Although the chain can be set in a chain vise in the same manner as shown in 1) (with S type), this setting damages the chain because the inner link is made of engineering plastic.
- For this reason this cutting method cannot be used.
- Support outboard roller "A" on the upper side with a chain vise as shown above and lightly tighten the chain vise. Bring the outer link to be cut to the end of the chain vise, as shown above.
- Apply the punch to the pin end of outboard roller "A" and lightly tap the punch with a light hammer. Outboard roller "A" will be removed as shown below.

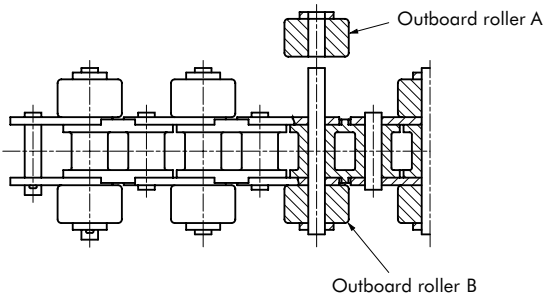

- Turn the chain upside down and remove outboard roller "B" by following the same procedure for removing outboard roller "A."
- Set the chain after removing outboard rollers "A" and "B" on the cradle as shown below, tap the punch lightly with a hammer, and remove the two pins. Pull out the pins up to a position where the upper outer link is removed. (Prepare a cradle yourself as appropriate.)

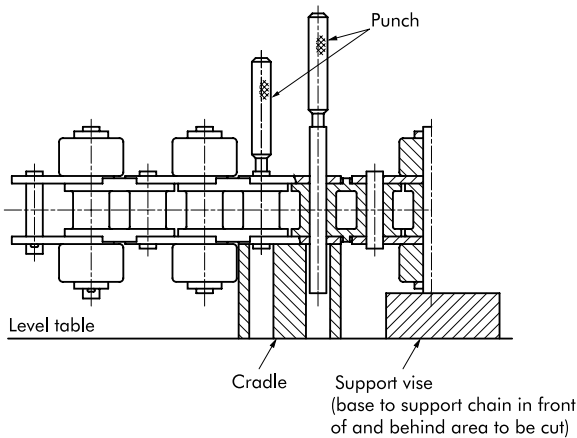

3.7 Cutting Top Roller Chain

- 1) Cutting chain when the base chain roller is an S roller

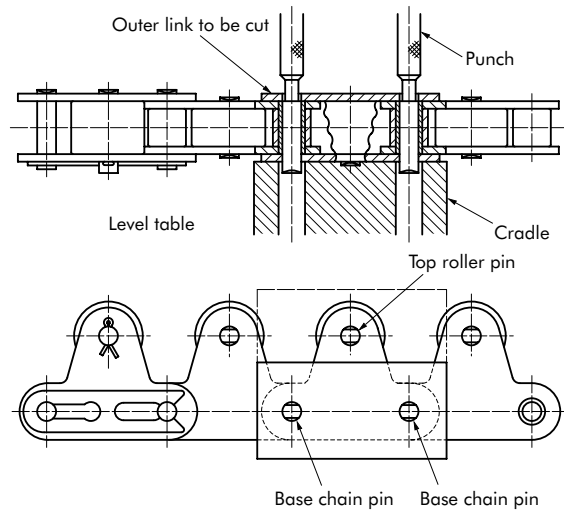

- a. Mark the outer link to be cut for identification.
- b. Shear off the rivets on the base chain pin ends and top roller pin ends using a hand grinder or other means (three rivets on one side of the chain).
- c. Turn the chain side ground by the grinder upward and set the chain on a cradle, as shown above. Prepare a cradle yourself as appropriate. To remove the three pins including the top roller pin at the same time, prepare a cradle integrating the part shown by the phantom line.
- d. Tap the punch (or its equivalent) with a hammer until the two (three) pins are removed from the outer plate (up to the position shown in the diagram).
- e. Change the setting of the cradle as shown below to remove the top roller pin. (When top rollers are not attached to the outer link, this procedure is not necessary.)
- f. Remove the top roller pin by repeating Step d.

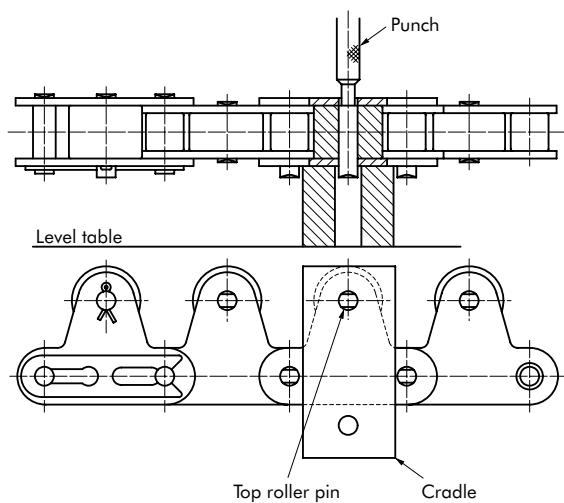

4. CONNECTING TSUBAKI ATTACHMENT CHAIN

4.1 Assembling with a Connecting Link

- 1) Insert the pins of the connecting link into the bushes of the free inner links. Place the free link plate over the pin ends and secure using a spring clip or cotter pins.
- 2) The pins are slip-fit into the connecting plate, meaning the pins can be inserted manually.

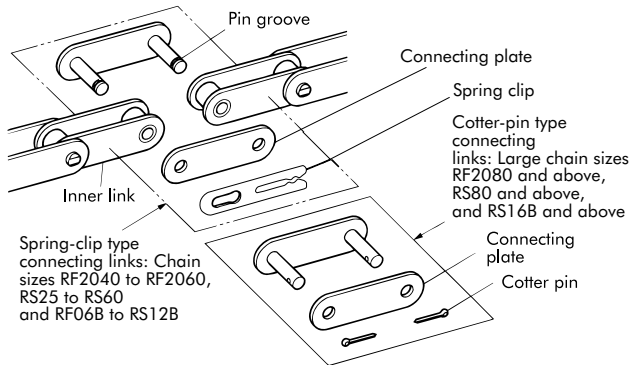

How to connect attachment chain

4.2 Installing Spring Clips

Check that the spring clip is securely attached. Failure to install the spring clip or improper installation may result in an accident.

- 1) Spring clips are used to secure the connecting links of chains RF2060, RS12B, RS60 or smaller. Insert the pins of the connecting link into the bushes of the free inner links, place the link plate over the pin ends, and slide the spring clip over the ends of the pins so that the slot and the fingers of the clip engage the grooves securely.
- 2) Pay careful attention to ensure that the fingers of the spring clip are not spread too wide. If the spring clip does not fit securely, it could become detached without warning, leading to an accident.

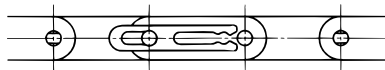

Slide spring clip over grooves in pin ends

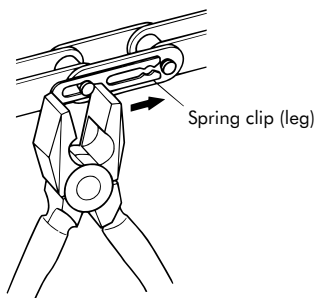

Use a pair of pliers to secure spring clip

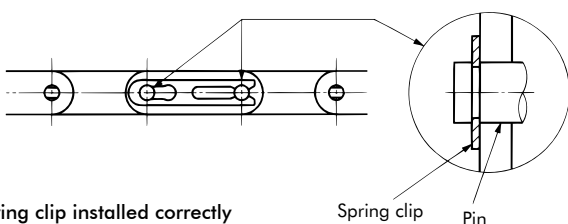

Spring clip installed correctly

Spring clip Pin

- 3) In general, the spring clip should be installed in the direction opposite to chain travel, as shown in the drawing below.

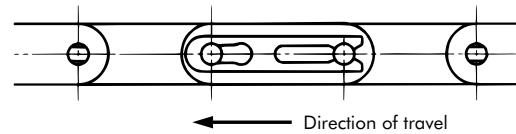

4.3 Installing Cotter Pins

Securely install the cotter pins in the holes provided on the ends of the pins. Failure to install the cotter pins or improper installation may result in an accident.

- 1) After the cotter pin has been fully inserted into the hole on the end of the pin, open the legs of the cotter pin to an angle of around 60°. Do not re-use cotter pins. Do not use commercially available cotter pins.

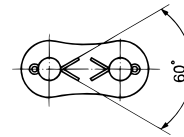

Open legs of cotter pin

- 2) How to open the legs of the cotter pin

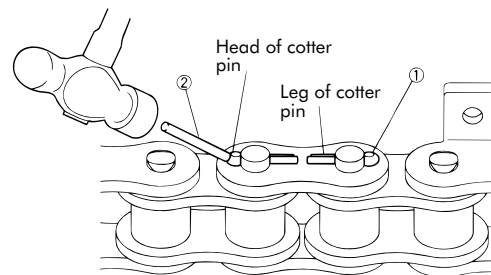

- a. Insert the cotter pin into the cotter pin hole.
- b. Use a pin that is somewhat larger in diameter than the cotter pin to lightly tap the head of the cotter pin. The legs of the pin will open slightly.

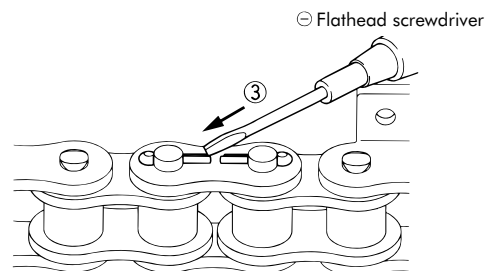

- c. Insert the blade of a flathead screwdriver at the point where the legs of the cotter pin have opened slightly.

⚠ Caution

Perform this operation with extreme care! If the end of the screwdriver slips, it could puncture the hand or cause other injury.

4. CONNECTING TSUBAKI ATTACHMENT CHAIN

- d. Insert the blade of the flathead screwdriver at an angle and move the screwdriver back and forth to open the legs of the cotter pin.
- e. Press down the head of the cotter pin tightly so that the cotter pin will not disengage from the cotter pin hole.
- f. Bend the cotter pin legs to the 60° angle mentioned above.

4.4 Connecting Chain with Outboard Rollers

Chains are connected using connecting links.

- 1) When the outboard rollers are arranged in a staggered installation

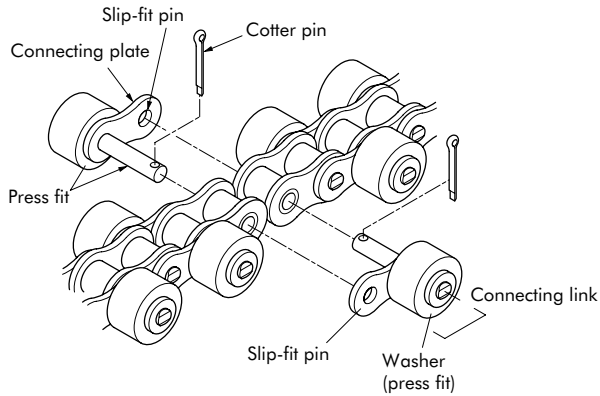

- a. Pass the two pins of the connecting link through the holes of the inner link and then through the slip-fit connecting plate.
- b. Insert a cotter pin through each pin and open the legs of the cotter pin to an angle of about 60°.

- 2) When the outboard rollers are arranged in a crosswise installation

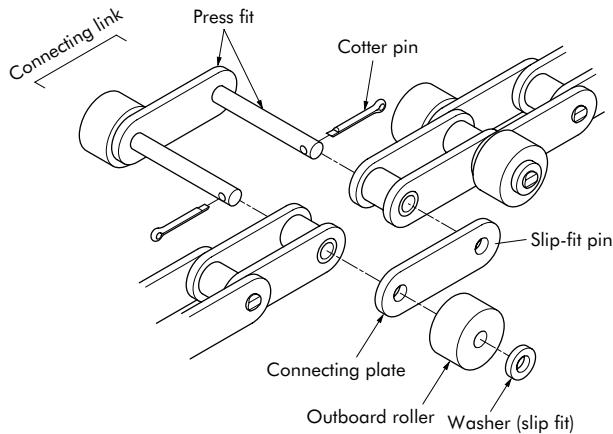

- a. Pass the two pins of the connecting link through the holes of the inner link and then through the slip-fit connecting plate.
- b. When installing outboard rollers on both sides of a pin as shown above, pass the pin through the outboard rollers and washer, and attach cotter pins in two places. Open the legs of the cotter pins to an angle of about 60°.

4.5 Connecting Top Roller Chain

- 1) Chains are connected using connecting links.
 - a. There are two types of connecting links. Use caution when placing an order for connecting links to ensure correct order placement.
 - b. The outer diameter of the top roller differs in chain with top rollers installed on every link and in chain with top rollers installed on every second link. Refer to the dimensional drawing for the dimensions of these top roller chains.

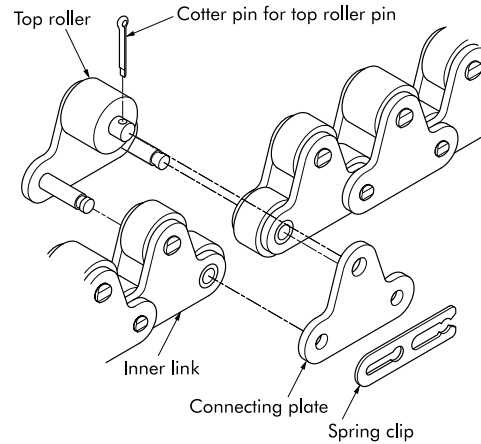

Spring clip-type connecting link

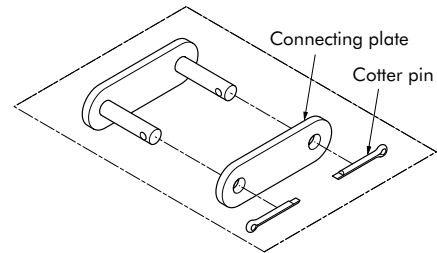

Spring clip-type connecting link

- 2) Pass the two pins of the connecting link through the bushes of the inner link and then through the holes of the connecting plate (the connecting plate is slip fit).
- 3) Fit a cotter pin or spring clip securely on the pin. Open the legs of the cotter pin to an angle of about 60°.

5. INSTALLING TSUBAKI ATTACHMENT CHAIN

5.1 Horizontal Precision and Parallelism of the Shafts

Installation accuracy of the sprockets greatly affects the smoothness of the attachment chain drive and also influences the wear life of the attachment chain.

Make sure to carry out the following instructions correctly:

- 1) Check the horizontal precision with a level. Adjust the shafts so that they are horizontally within 1/300 precision.

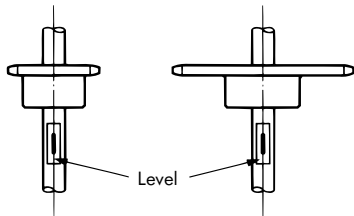

- 2) Check the parallelism with a scale. Adjust the shafts so that they are parallel to within $\pm \frac{1}{100} = \left(\frac{A-B}{L}\right)$

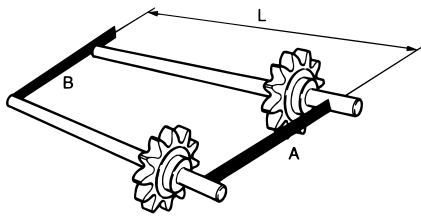

- 3) Using a straightedge or scale, adjust the two sprockets so that they are parallel. Adjust to within the following values based on the distance between the shafts.

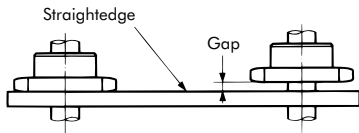

Centre Distance	Alignment Accuracy
up to 1 m	$\pm 1 \text{ mm}$
1 m to 10 m	Centre Distance (mm) / 1000
over 10 m	$\pm 10 \text{ mm}$

Misalignment can be measured with:

- A straightedge when the distance is short
- A piano wire when the distance is long
- A leveling string or a piano wire when the sprocket positions are different from each other in terms of sprocket height

- 4) After processes 1) to 3) have been completed, lock each of the sprockets to the shaft(s) by means of keys or Tsubaki Clamping Elements. Lock the sprockets that are installed and used on the same shaft so that the teeth of both sprockets align in terms of phase)

5.2 Centering

Because the attachment chain runs on a guide rail, the position of the guide rail must be very accurate and the attachment chain must be properly centered. In case of vertical bucket elevators, where there are no guide rails, the chain will sinuate erratically if not precisely centered. This will have a significant impact on the life of the attachment chain.

5.3 Rails

In general, rails wear faster than chain. While it is important that the rail material be matched to the chain material, in general, rolled steel for general structures (SS400) or plastic material (ultra-high molecular weight polyethylene) is recommended.

- 1) Wear is a complex phenomenon and is influenced by a variety of factors, including corrosion, lubrication, load, speed and operating time. Deducing the precise relationship between chain life and rail material is difficult.
- 2) Chain life is influenced by the rail. For new installations, verify the wear state by selecting rail material that is slightly softer than the chain. The smoother the finish on the rail surface, the better.
- 3) Operating conditions must be taken into consideration when selecting materials. In environments involving mechanical impact and other special conditions, there may be cases when plastic should not be used.
- 4) Precautions before putting rails into operation
 - a. Lubricate all rail connecting parts, chamfer edges, and eliminate uneven levels and gaps.
 - b. After welding rail, remove sputter or scale.
 - c. During the trial run, run the conveyor unloaded. Lubricate the chain and check the condition of chain and rails.

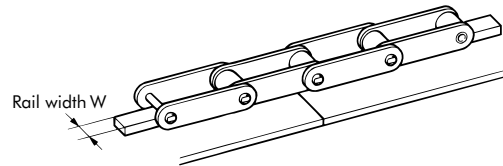

Rail width W is generally set to the sprocket facewidth.

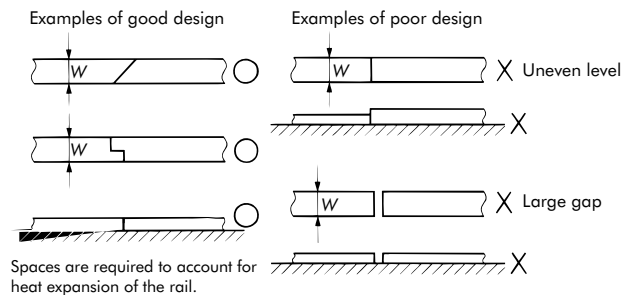

Rail joints

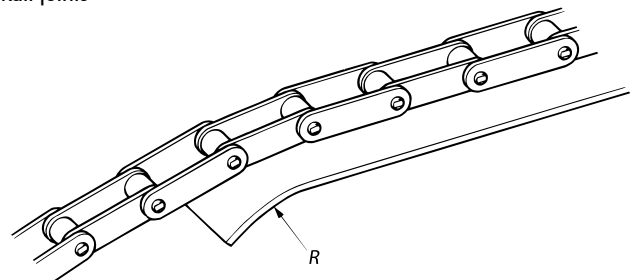

Chain entrance/exit from guide rail

To ensure that the chain moves smoothly bend the guide rail to a radius of R at the points where the chain engages and disengages from the rail.

6. LUBRICATION

6.1 Attachment chain

Proper lubrication is the key to extend the life and improve the performance of a chain. In order to get the best performance in general applications (-10°C to +60°C), all drive chains are pre-lubricated. Attachment chains however are NOT pre-lubricated, but have been treated with rust preventive oil for protection and therefore need to be lubricated before the chain is installed. The reason TSUBAKI does not pre-lubricate attachment chains is due to the fact that attachment chains often have a function in various environments where standard lubrication cannot be used.

For special applications and on customer's requirement, TSUBAKI can provide attachment chains which are pre-lubricated with a special lubricant which include:

- High temperature
- Low temperature
- Food safe
- Outdoor exposure
- Dusty environment

Please consult TSUBAKI for more detailed information.

- 1) The purpose of lubrication is to reduce wear on chain parts, prevent corrosion (rust), and economize on power demands.
- 2) Lubricate the chain periodically (about once a week) so that the chain always remains damp with oil. Perform drip lubrication or apply lube with a brush.
- 3) Lubrication locations
 Since wear between pins and bushes causes chain elongation, lubrication must be maintained on all contact surfaces. Also, areas where chain parts (plates, etc.) come into contact with guide rails must be lubricated.

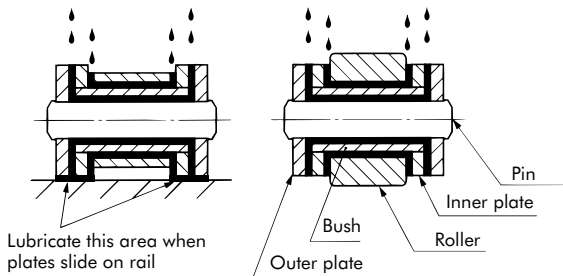

6.2 Double Plus

Double Plus with plastic rollers is designed to operate in a dry environment without contamination from water or oil. Otherwise, the start-up function of the chain will be minimized or eliminated, making conveying difficult. Double Plus with plastic rollers is designed to operate without lubrication. However, if the chain begins to make noise in the sprocket area because of a lack of oil, lubrication may be applied carefully, at the space between the link plates. If oil gets on plastic rollers, clean them immediately.

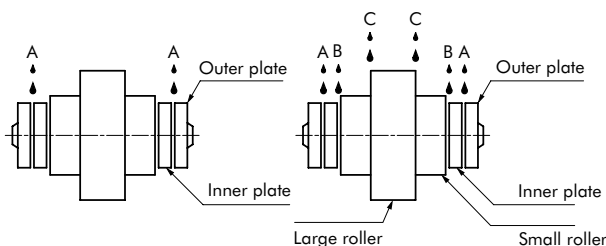

Plastic roller lubrication

Steel Roller lubrication

Double Plus with steel rollers requires lubrication. Apply a small amount of lubrication (SAE10 to 20) in area's "A", "B" and "C". A lubricator with a sharp pointed tip like a syringe is convenient to use for lubrication. Wipe off excess oil from the periphery of large and small rollers.

6.3 Outboard Roller Chain and Top Roller Chain

- 1) If parts making up the chain are made of steel, lubrication is generally required (see diagram below). There is no need for lubrication on the base chain and engineering plastic rollers of Lambda chain.

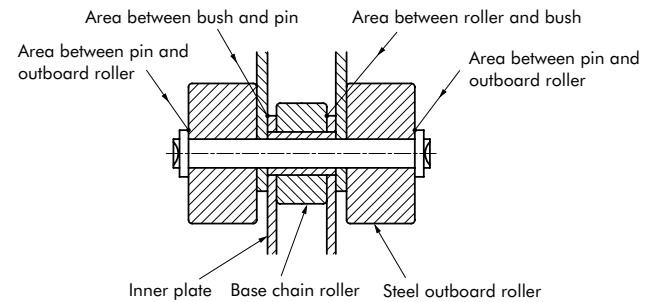

Lubrication positions on outboard roller chain

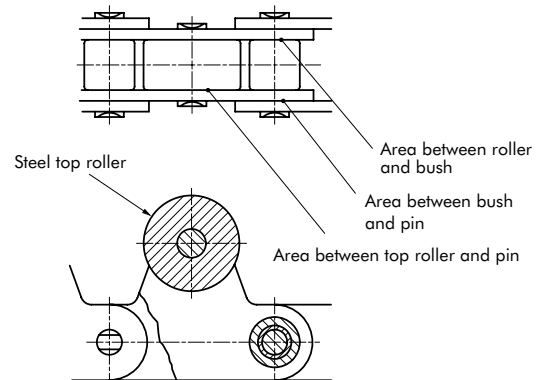

Lubrication positions on top roller chain

- 2) Lubricate these parts regularly (about once a week) to avoid running out of lubrication. Perform drip lubrication (using lube listed below) or apply lube with a brush.

Lubrication Method	Drip or Brush				
	Ambient Temp.	-10°C to 0°C	0°C to 40°C	40°C to 50°C	50°C to 60°C
Pitch					
5/8" or smaller pitch	SAE10W	SAE20	SAE30	SAE40	
3/4" - 1" - 1 1/4" pitch	SAE20	SAE30	SAE40	SAE50	
1 1/2" or larger pitch	SAE30	SAE40	SAE50		

7. TENSION ADJUSTMENT

The correct amount of chain slack is essential for proper operation of the chain. When the chain is too tight, working parts such as chain, sprocket wheel, shaft, bearings, etc., carry a much heavier load, accelerating chain wear. On the other hand, too much slack is also harmful and causes the chain to climb the sprocket teeth.

1) Frequency of Adjustment

The chain has a tendency to stretch a certain amount at the beginning of operation due to slight distortion of its components. After such initial elongation, the chain stretches slightly, but constantly, as a result of normal wear. To maintain proper chain tension, adjustments, if necessary, should be made at regular intervals. Assuming eight hours of operation a day, the frequency schedule for inspection and adjustment is given in the table below. When working hours are increased, the frequency of adjustment should be increased accordingly. Neglect of careful inspection increases the chance of an accident.

1st week after start of operation	Once a day
2nd to 4th week after start of operation	Twice a week
Thereafter	Twice a month

2) Insufficient Take-Up Adjustment

If there is still excessive slack in the chain even after the take-up adjustment is fully tightened, shorten the chain by removing two links.

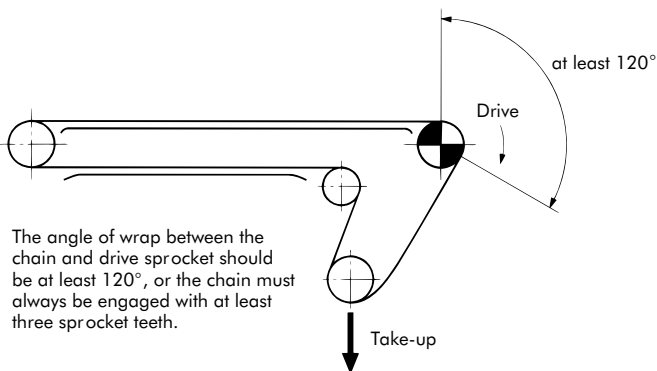
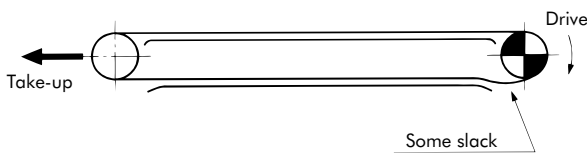

Adjusting chain slack

3) Even Adjustment of Take-Up on Both Sides

Where two parallel chains are adjusted by two independently operated take-ups, care must be taken to ensure even stroke on both the left and right side (not needed when the take-ups are cooperating screw type or counterweight type). An uneven adjustment will cause the link plate and the side of the sprocket teeth to interfere with each other and result in an overload condition. When the right and left sides are uneven, the two chains should be made even by replacing a portion of the right and left chains.

8. CHAIN TEST RUN

After installing the chain, carry out a test run and check the following items before you actually start running the chain.

8.1 Before beginning Test Run

- 1) Connecting spring clips and cotter pins are installed correctly.
- 2) Chain slack is adjusted properly.
- 3) Lubrication is adequate.
- 4) The chain does not come into contact with casing or covers.

8.2 Test Run

- 1) There are no strange noises.
- 2) There is no excessive chain vibration.
- 3) The chain does not run up on the sprockets.
- 4) The chain is not jammed into the sprockets.
- 5) The rails and sprockets are installed correctly.
- 6) The rollers rotate smoothly.
- 7) There are no stiff areas during chain articulation.

Caution

An unloaded trial run should be conducted after installation by intermittently switching the system on and off several times. After inspection, a continuous unloaded trial run should be conducted. Prior to the trial run, be sure to lubricate the chain to allow lubricant to work into various components.

9. ATTACHMENT CHAIN INSPECTION

Frequently inspect the chain during the initial operating period in order to carry out necessary adjustment. Inspect the following items:

- 1) Unusual wear of chain.
- 2) Slack in chain.
- 3) Vibration and jerking of chain.
- 4) Unusual wear of sprocket, unusual contact of sprocket with other components due to eccentricity, dust accumulated on root of teeth.

When the sprocket properly engages with the chain, even contact is represented by the trace of contact shown as A in the illustration, while uneven trace of contact as B in the illustration represents improper installation of the sprocket or a twisted chain. Rechecking is needed. Proper contact should be traced a little above the root.

However, when initial tension remains in the slack side of the chain, the chain slightly contacts the root.

However, even in this case, strong contact should be traced around A.

In the case of idlers and tensioners, contact happens at the middle of the root.

- 5) Too much wear of guide rail.
- 6) Any abnormality in the lubricating system.

Causes of Vibration, Jerking, and Unusual Wear

- 1) Overload, glass fragments caught between components.
- 2) Warping of the chain on the return side.
- 3) Insufficient lubrication or no lubrication.
- 4) Wear of the sprocket.
- 5) Unusual wear or breakage of the chain.

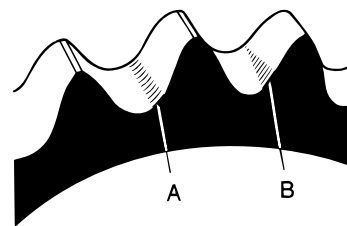

10. USAGE LIMITS

10.1 Chain Wear Elongation

The chain should be measured by stretching it slightly to remove any backlash or looseness. Measure the distance of the inside (L1) and outside (L2) of rollers at both ends of the measured links to obtain measurement (L). When measuring, use at least 6 to 10 links to help keep any measuring error to a minimum.

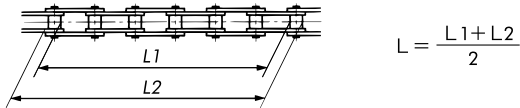

$$\text{Chain wear elongation (\%)} = \frac{\text{Measured length (L)} - \text{Standard length}}{\text{Standard length}} \times 100\%$$

Standard length = Chain pitch X No. of links

The chain should be replaced when wear elongation is greater than 2% of the chain pitch.

A chain wear measurement scale that allows easy checking of elongation is available from TSUBAKI.

For Lambda Chain, if the chain elongation reaches around 0.5%, then the oil has run out. Indicators of this condition are red wear dust between the plates and occurrence of bad chain articulation. In this situation the chain is no longer usable and should be replaced.

10.2 R Rollers

When wear between the bush and roller causes the under surface of the link plate to contact the guide rail, the chain has usually reached the end of its usable service life. When the link plate starts contacting the guide rail, rolling contact suddenly turns into sliding contact between the link plate and rail, resulting in greater wear, an increase in chain tension and required horsepower.

10.3 S Rollers

The chain has reached the end of its service life as soon as holes or cracks appear on the rollers due to wear.

10.4 Link Plates

For conveyor configurations in which link plates move directly on the material to be conveyed or on a guide rail, the service life has come to an end when the worn section equals H/8, as shown in the drawing.

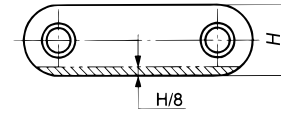
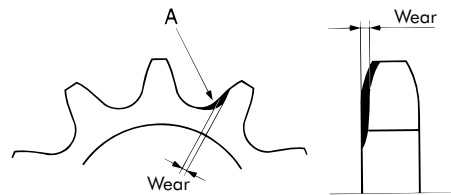

Plate width wear

10.5 Sprockets

When the sprocket is worn as illustrated below (to the left), the chain is prone to being caught by the tips of the teeth (A), making the departure of the chain from the sprocket difficult, hence resulting in vibration of the chain. Though wear allowance depends on the type of conveyor and the size of the chain to a certain extent, if the sprocket is replaced when the wear reaches 0.3 to 1.0 mm, damage to the chain can be avoided. When the sprocket is worn in the direction of the facewidth as illustrated below (to the right), the shaft may not be properly aligned, therefore correct it.



Wear of sprocket teeth

11. OTHER PRECAUTIONS

11.1 Shutdown/Restart

Stop the conveyor under no-load conditions to prevent remaining material from overloading the system when the conveyor starts again. Also, if the conveyor system has been shut down for a long period of time, be sure to inspect the chain before restarting.

11.2 Securing Conveyor Parts

Parts fastened to the conveyor such as buckets, aprons, slats, etc., tend to loosen as a result of vibration. Pay careful attention to fastening nuts and bolts, and check periodically that they are tightly fastened.

11.3 Temperature and Prevention of Freezing

Conveyor damage may occur when differences in temperatures (between day and night in winter) are extreme. Under these circumstances, operate the conveyor carefully, taking into account any variations in temperature as well as appropriate lubrication, the moisture content of the conveyed material, inspections, etc.

11.4 Spare Chain Storage

In the unlikely event of a failure or accident, we recommend that a spare chain be prepared in advance. This spare chain should be stored in a dry space. Also, if the chain is to be stored for a long period of time, it should be coated with a rust-preventive oil. For convenience, attach a tag noting the product name, model number, date of purchase, and equipment it is intended to be used on.

11.5 Record of Use and Maintenance

Beyond the maintenance and inspection items mentioned above, after installing the conveyor, prepare a record of the expected capacity to be conveyed, conveying speed, r/min. of main shaft, electric current, voltage, power, working hours, actual conveying capacity, inspection dates, lubricating dates, details of problems, and the like. This will serve as protection against unexpected accidents. When updated on a regular basis, this record will also be convenient for maintenance and repairs.

11.6 Cleaning

The chain should be cleaned periodically to remove contamination or particles of conveyed material from the chain and rail.



11.7 Storage of Chain and Sprockets

Chain and sprockets should be stored in a place free of dust and dirt and where they will not be exposed to rain. To prevent rust, use a brush to coat sprockets with oil. No rust-prevention treatment is applied at the time chain is shipped. Therefore, when storing chain, coat with a rust-preventive oil and inspect periodically for corrosion.

12. ATTACHMENT CHAIN TROUBLESHOOTING AND PROBLEM SOLVING

When there is significant damage, breakage or other problems experienced with conveyor chains, identify the correct remedies from symptoms as listed, and replace chain and sprockets where necessary.

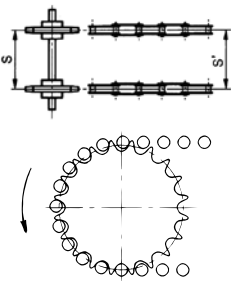
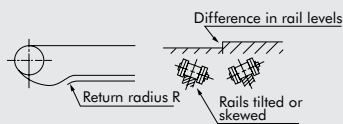
12.1 General

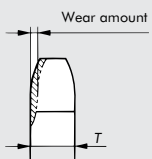
Problem	Possible Cause	Solution
 <p>Chain rides up on the sprocket</p>	Chain and sprocket do not match.	Replace the chain or sprocket with the correct size.
	Excessive load.	Reduce the load, add lubrication, or increase the size of the chain.
	Elongation of the chain due to wear or excessively worn sprocket teeth.	Replace with new chain and sprockets.
	Angle of chain wrap on the sprocket is insufficient.	Chain must be engaged with at least three sprocket teeth. Angle of chainwrap should be at least 120°.
	Inadequate back-tension.	Adjust the catenary of take-up idler, or install a tensioner.
	Distance between the center of the chain and the sprocket do not match. $S \neq S^1$	Inspect and correct.
<p>Unusual noises</p>	Improper installation of the sprocket or shaft.	Inspect and correct.
	Chain casing or bearings are loose.	Tighten all bolts and nuts.
	Excessive or insufficient slack in the chain.	Adjust the distance between the shafts to obtain the proper amount of slack or install a tensioner.
	Excessively worn chain or sprocket.	Replace with new chain and sprockets.
	Lack of or unsuitable lubrication.	Provide proper lubrication according to the operating conditions.
	Interference of casing with the chain or other moving parts.	Inspect and correct.
	 <p>Improper guide rail installation.</p>	Inspect and correct.
 <p>Chain winds onto the sprocket (poor separation from the sprocket teeth)</p>	Excessive slack in chain.	Adjust the chain length or the distance between shafts. Or install a tensioner.
	Elongation of the chain due to chain wear or excessively worn sprocket teeth.	Replace with new chain and sprocket.
	Distance between the center of the chain and the sprocket do not match.	Inspect and correct.
	Span between shafts is too large.	Install a guide or an idler.
	Poor chain articulation due to rust, caused by bad environment, or due to inappropriate lubrication.	Replace the chain. Protect the chain from the environment by appropriate lubrication and/or cover.
 <p>Excessive wear on the inside surface of the link plates and sides of the sprocket teeth</p>	Improper installation	Correct sprocket and shaft installation.
	Chain is being pushed to the side.	Remove the cause of the push and/or install a guide roller.
<p>Chain is rusting</p>	Inappropriate selection of material.	Select a more suitable chain material.
	Improper lubrication or poor environment.	Replace chain and protect the chain from the environment by appropriate lubrication and/or a cover.
Excessive wear on the outside surface of the link plates and pin heads	Improper installation of guides, etc.	Check the condition of the guides, and increase the gap between the guides and the chain.

12. ATTACHMENT CHAIN TROUBLESHOOTING AND PROBLEM SOLVING

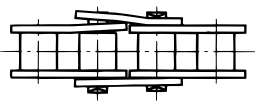
Problem	Possible Cause	Solution
 <p>Poor articulation</p>	Chain is not installed correctly.	Inspect installation and correct as necessary.
	Chain and sprocket do not match.	Replace chain or sprocket.
	Contamination from metal dust or dirt because of improper lubrication.	Remove the chain, wash it thoroughly, and provide proper lubrication.
	Excessive load (causing bent pin, or cracked bush)	Reduce the load or increase the size of the chain.
	Corrosion.	Install a partition to protect the chain. Select a suitable chain.
	Inadequate lubrication.	Provide adequate lubrication.
	Foreign particles stuck in clearance.	Install a partition to protect the chain.
	High temperatures.	Consult with Tsubaki regarding this situation.
<p>Spreading of link plates.</p> 	Uneven or excessive loading caused by improper installation.	Replace with new chain and correct installation.
<p>The chain sticks and slips (This can be caused by a combination of many problems; Therefore, the listed remedies may not solve the problem.)</p>	The conveyor speed is too slow.	Increase conveyor speed.
	Insufficient rigidity in the conveyor system.	Increase the frame rigidity; Increase the chain size.
	The force of friction is excessively large.	Lubricate between the guide rail and chain. Or switch to Bearing Roller Chain.
	The conveyor system is too long.	Divide the conveyor system into sections to decrease the length.
	Inconsistent speeds due to movement along a polygonal path.	Use a 12 or more toothed drive sprocket.

12. ATTACHMENT CHAIN TROUBLESHOOTING AND PROBLEM SOLVING

12.2 Link Plate Related



Static fracture

Stretching the link plate with a tensile load beyond its breaking load will cause it to stretch and then break.

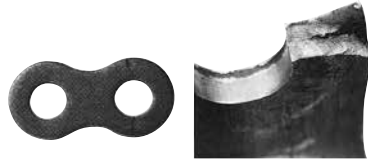

Fatigue fracture

By repeatedly applying a load past its fatigue limit (fatigue strength), the fatigue will start at holes and then suddenly cause the chain to break

Problem	Possible Cause	Solution
Static Fracture Breakage of link plate.	Excessively large shock load.	Reduce shock loads by making the start-up, stopping, and other actions smoother (install a shock absorber). Increase the size of the chain.
	Vibration.	Install an anti-vibration device such as a tensioner or idler.
	Corrosion	Install a partition to protect the chain. Select a suitable chain.
Fatigue Fracture Breakage of link plate.	Repetitive loads are greater than maximum allowable load.	Reduce the load, increase the size of the chain.
	Repetitive load on attachments are greater than maximum allowable load.	Reduce the load, increase the size of the chain.
Deformation of link plate holes.	Excessive load.	Reduce the load, increase the size of the chain.
Corrosion stress cracks appear, usually as bow-shaped cracks in the link plate.	The chain is being used in an acidic or alkaline environment.	Install a partition to protect the chain. Select a suitable chain. (Please consult Tsubaki.)

12. ATTACHMENT CHAIN TROUBLESHOOTING AND PROBLEM SOLVING

12.3 Pin Related



Static fracture

The type of fracture found when subjecting the chain to the breakage test. Occurs when the chain is subjected to a load greater than its breakage strength.



Fatigue fracture

Occurs when the pin is repetitively subjected to loads greater than its fatigue limit. Recheck the size of the peak load and formulate a countermeasure.



Shock-induced bending fracture

The pin is subjected to a large shock load and breaks. The side with the initiating point receives tensile load and the fracture progresses from this point. The pin is especially susceptible to becoming weak with regard to bending when the surface of the pin has corroded. This type of phenomenon occurs quite easily.

Problem	Possible Cause	Solution
Breakage of pin.	Excessive large shock load.	Reduce shock loads by making the start-up, stopping, and other actions smoother (install a shock absorber). Increase the size of the chain.
	Loads are greater than maximum allowable load.	Reduce the load, increase size of the chain.
	Corrosion.	Install a partition to protect the chain. Select a suitable chain.
Pin rotates or begins to stick out.	Excessive load.	Replace chain immediately. Reduce the load, increase the size of the chain.
	Operating a chain with high load without proper lubrication can create friction between the pin and bush, causing the pin to rotate.	Replace chain immediately. Provide proper lubrication according to the operating conditions.
Wear or rust occurs only at the connecting pin.	Improper initial lubrication at installation.	Replace the connecting link. Provide proper lubrication.

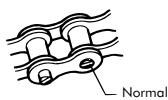

12. ATTACHMENT CHAIN TROUBLESHOOTING AND PROBLEM SOLVING

12.4 Bush / Roller Related

Problem	Possible Cause	Solution
Roller and/or bush splits in two pieces.	Excessive load.	Reduce the load, increase the size of the chain.
	Inadequate lubrication.	Provide adequate lubrication.
	Too few teeth with respect to conveyor speed.	Increase the number of teeth or decrease the speed.
Improper roller rotation and uneven roller wear.	The inner link plate is forced inwards.	Re-inspect the installation and load conditions.
	Bush is cracked.	Reduce load and lower the speed.
	Particles of conveyed material, or other foreign particles stuck between the bush and roller.	Periodically clean the chain. Install a partition to protect the chain.
	Excessive load on the rollers.	Reduce excessive loads. Provide sufficient lubrication. Increase the size of the chain.
	Lubricant is falling on the roller surface and rail without entering between the bush and roller or between roller and link plate.	Select an appropriate lubricant and lubrication method.
	Particles of conveyed material, or other foreign particles have built up on the rail.	Clean regularly, and install a partition to protect the chain/rail.
	Rust on the bush and/or rollers.	Select a more suitable chain material.
Roller is opening up.	Excessive load. 	Reduce the load. Provide adequate lubrication.
Roller is becoming hourglass shaped.	Excessive load or inadequate lubrication.	Replace with new chain. Improve the lubrication or loading conditions.
	Excessively worn rail.	Replace the rail.

1. INTRODUCTION TO TSUBAKI CONVEYOR CHAIN

As you would expect from the global leader for industrial chain manufacture, TSUBAKI offers a wealth of experience, expertise & solutions to customers with requirements of large pitch conveyor chain.

Being specific to our local markets TSUBAKI Europe offers products to the ISO/DIN standard in many combinations of steel and specification, particularly in the M & FV series.

But being an international organization we are able to provide solutions to other international standards for a wide variety of customer's applications including the TSUBAKI RF series conveyor chain. This series demonstrates TSUBAKI's vast knowledge gained through research & development providing solutions to wear, heavy duty applications, longer life and specific requirements to reduce chain noise and even obtain accurate product indexing.

With the most advanced chain manufacturing technology, we supply both a high and consistent quality of products to achieve outstanding performance resulting in improved chain life, reduced maintenance and cost of ownership.

Everything you would expect from TSUBAKI and more.....

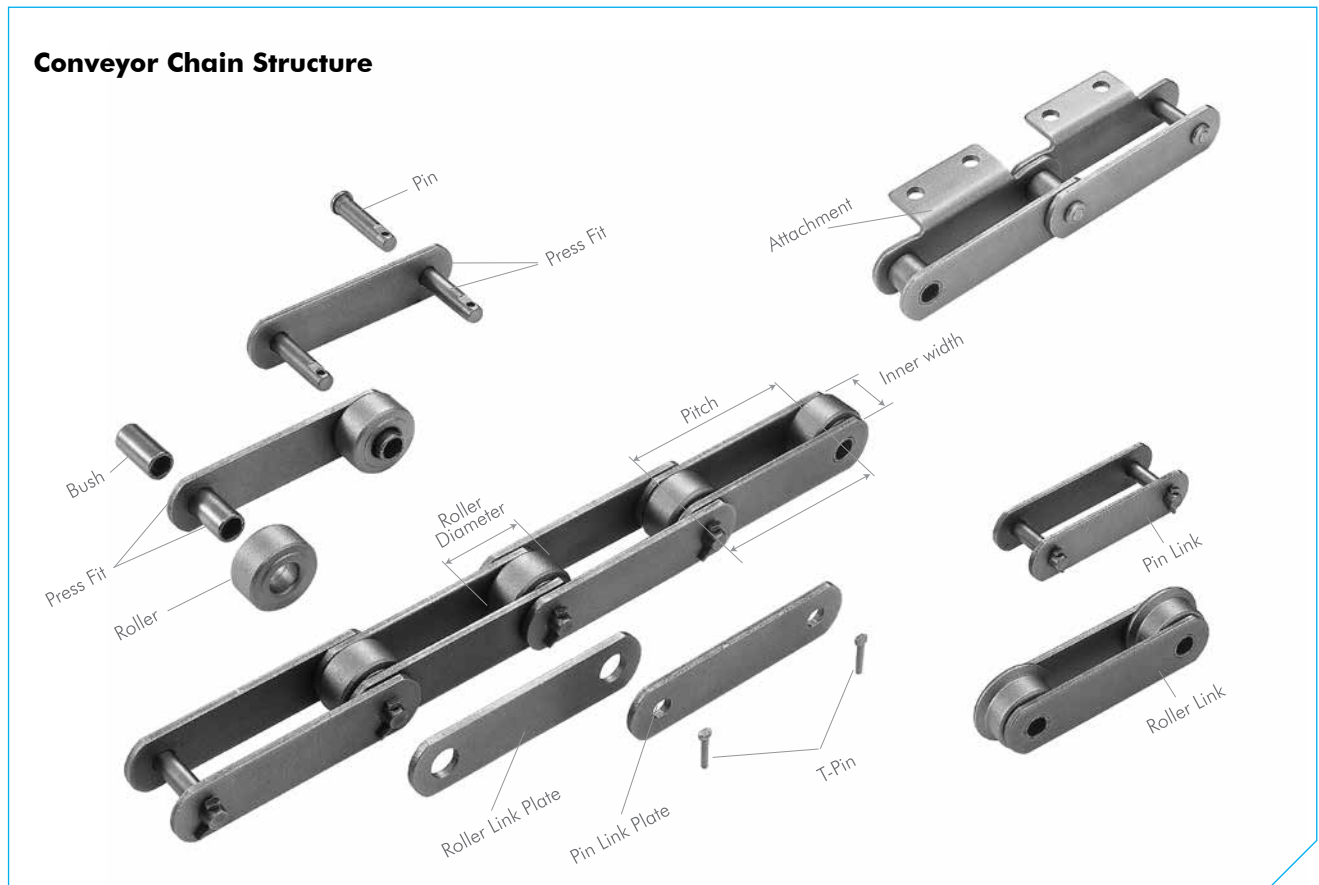

1. INTRODUCTION TO TSUBAKI CONVEYOR CHAIN

Basic Parts

Link Plate

Link plates are the component parts receiving chain tension. The holes for press-fitted pins or bushes are accurately punched to maintain uniform pitch.

Roller

Rollers are free to rotate over the bushes. When the chain engages with the sprocket, rollers work as bearings and serve to reduce shock and wear. When the chain is running on rails or wear strips, the rollers reduce running friction on the chain.

Type of Roller

TSUBAKI Conveyor Chains use three basic roller types. Illustrated below are examples used with guide rails.

1. R Roller

TSUBAKI's most basic, versatile roller type is the R Roller. It has a large allowable load and low frictional resistance. The outside diameter of the roller is larger than the height of the link plate, so the chain can roll on the guide rail. R Rollers are suitable for carrying large and heavy materials.

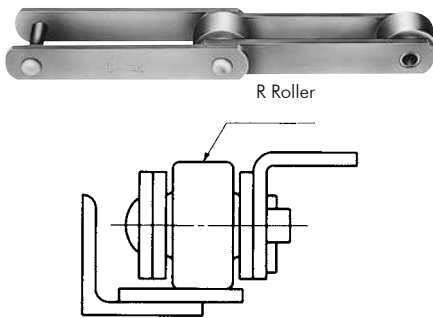

2. F Roller

Flanged rollers have a flange on the roller which acts as a guide. Flange rollers are a simple way to prevent side oscillation. They are perfect for rough usage conditions and regular slat conveyance. F Rollers are also suitable for carrying large and heavy materials.

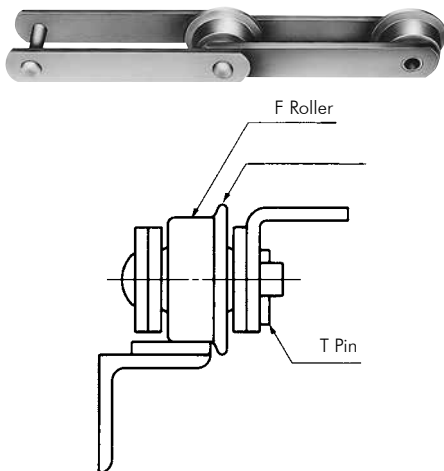

3. S and M Roller

The outside diameters of the S and M rollers are less than the heights of the link plate and are specified depending on the application. These rollers are effective in alleviating the shock and wear the chain would normally suffer during sprocket engagement. The outer diameter of the S Roller is smaller than the height of the link plate. The outer diameter of the M Roller is slightly larger than that of the S Roller.

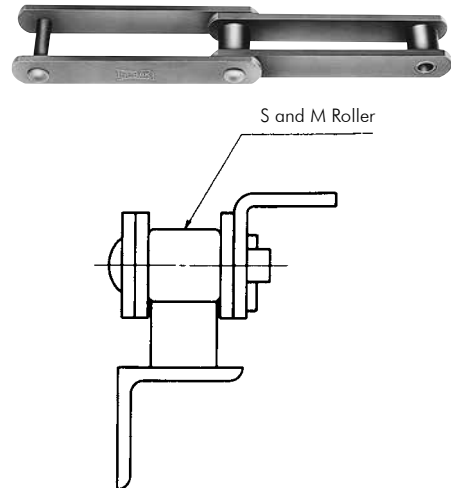

Bush

Bushes are made to obtain high wear resistance then press-fitted to the roller link plates, providing a bearing surface for pin rotation.

Pin

Pins are made to exact specifications for high strength, sturdiness and wear resistance, then rigidly press-fitted to the link plates. Pins resist shearing force through chain tension and rotate in the bushes, providing bearing surfaces when the chain articulates over a sprocket.

1. INTRODUCTION TO TSUBAKI CONVEYOR CHAIN

Attachments

Attachments are provided when necessary for fixing items to the chain. According to the application and the size and shape of the material to be conveyed, various types of chain attachments can be provided. Some of them are standardized and known as A, K, GA, SK and SA Attachments. Attachments can be assembled at any required spacing.

1. K Attachment

K Attachment: bent type link plate on both sides. K-1, K-2, or K-3 indicates K Attachment with one, two or three holes respectively.

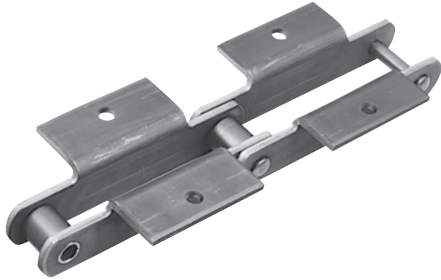

5. SA Attachment

SA attachment: straight attachment on one side only. SA-1 or SA-2 indicates SA Attachment with one or two holes, respectively.



2. A Attachment

A Attachment: bent type link plate on one side only. A-1, A-2, or A-3 indicates A Attachment with one, two or three holes, respectively.



6. Specialty Attachment

Deep Link, Outboard Chain, Top Roller Chain or Flow Conveyor Chain



3. GA Attachment

GA Attachment: Link plates with holes. GA-2 or GA-4 indicates GA Attachment with two or four holes, respectively.



4. SK Attachment

SK Attachment: straight attachment on both sides. SK-1 or SK-2 indicates SK Attachment with one or two holes, respectively.

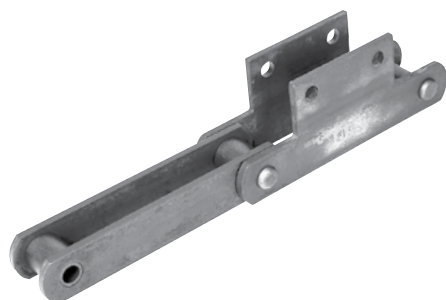

2. ORDERING TSUBAKI CONVEYOR CHAIN

When ordering TSUBAKI Conveyor Chain, please specify the chain dimensions and materials as well as the chain length, installation position and configuration of attachments.

For chain identification, see tables in catalogue 3 Custom Made Chain. It is equally important to confirm whether the chain is reinforced and what materials are used. You may need to verify the above with the equipment maker.

3. CUTTING TSUBAKI CONVEYOR CHAIN

In case of horizontal, inclined and vertical conveyors, beforehand ensure that the chain tension (load) on the chain is removed or otherwise supported by using block and wire etc.

- For riveted conveyor chain type, grind down two pins (same side) to the surface of the link plate. Be careful not to over-heat the chain during the grinding process.
- Place a punch on the head of the grounded pin and then hit the head of the punch with a hammer. Make sure to hit the pins alternatively to ensure the pins are removed evenly and at the same time.

4. CONNECTING TSUBAKI CONVEYOR CHAIN

Unless otherwise specified, new conveyor chains are usually supplied in 3 or 5 meter lengths for easy handling. The chain is made in even numbers of pitches, with an inner link at one end and an outer link or connecting link at the other end, so they may be easily joined together.

The method of chain connection depends upon the type of connecting links used. Whichever type is used, we recommend:

- To ensure the chain on both sides of the assembly point
- Coat the pins with grease or oil, unless the chain has to run unlubricated
- Insert the pins into the two ends of the chain
- Place the loose plate over the ends of the connecting pins
- Force the loose plates, using a hollow punch and hammer or a hydraulic press, onto the pins
- Widening the plate holes or narrowing the pin diameter to make pin insertion easier will lead to dramatic loss of chain performance
- When the plate is seated insert T-pins, split pins or circlips or rivet the pin end
- Check the chain at this point to ensure that it articulates smoothly

5. INSTALLING TSUBAKI CONVEYOR CHAIN

5.1 Horizontal Precision and Parallelism of the Shafts

Proper alignment of sprocket and shaft is essential for smooth operation of conveyors and long service life of conveyor chain. To ensure correct alignment, proceed as follows:

Make sure to carry out the following instructions correctly:

- 1) Check the horizontal precision with a level. Adjust the shafts so that they are horizontally within 1/300 precision.

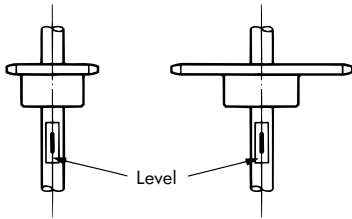

- 2) Check the parallelism with a scale. Adjust the shafts so that they are parallel to within $\pm \frac{1}{100} = \left(\frac{A-B}{L}\right)$

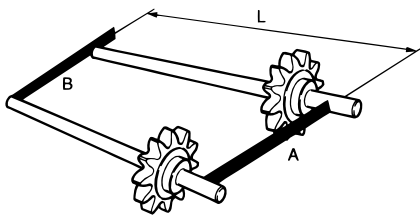

- 3) Using a straightedge or scale, adjust the two sprockets so that they are parallel. Adjust to within the following values based on the distance between the shafts.

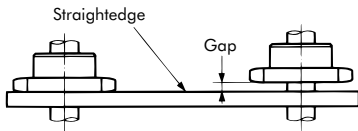

Alignment accuracy should be as follows:

Centre Distance	Alignment Accuracy
up to 1 m	± 1 mm
1 m to 10 m	Centre Distance (mm) / 1000
over 10 m	± 10 mm

Misalignment can be measured with:

- A straightedge when the distance is short
- A piano wire when the distance is long
- A leveling string or a piano wire when the sprocket positions are different from each other in terms of sprocket height

- 4) Secure each sprocket to the shaft with a Power Lock, Lock Sprocket, Taper Bush or keys (if needed use a collar, bolt sets, etc.)

PRO-ALIGN professional laser alignment system is available from TSUBAKI.

Please consult TSUBAKI for further information if required.

Note:

- It is required that at least three sprocket teeth are engaged with the chain.
- Installation of a take-up unit is an effective way to adjust for chain elongation.
- It is required to phase teeth of sprockets when multiple strands of chain are used in parallel.

5.2 Rail for Conveyor Chain

- 1) Rail connecting areas should be smooth and free of any edges, clearances or gaps.
- 2) Spatter and welding scales should be removed completely.
- 3) Trial run with lubrication after installation should be made under no load conditions. The condition of the chain and the chain rail should be checked.

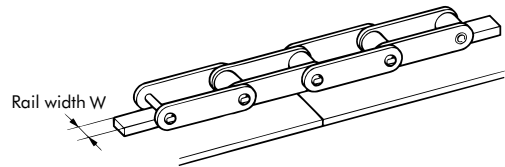

Rail width W is generally set to the sprocket facewidth.

Examples of good design

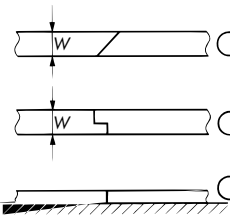

Examples of poor design

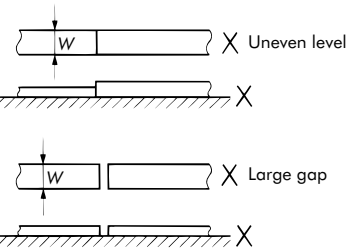

Spaces are required to account for heat expansion of the rail.

Rail joints

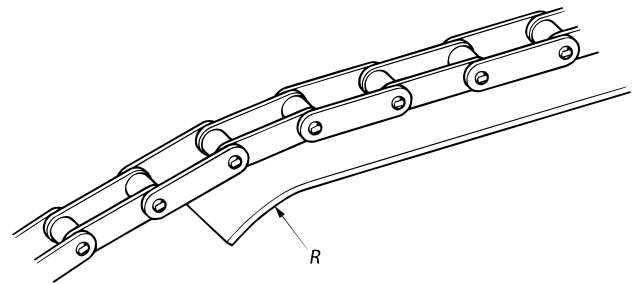

Chain entrance/exit from guide rail

To ensure that the chain moves smoothly bend the guide rail to a radius of R at the points where the chain engages and disengages from the rail.

6. LUBRICATION

As with other power transmission chains, TUSBABI Conveyor Chains require proper lubrication. Good lubrication reduces wear, economizes horsepower, and reduces chain pulsation. The greater the level of performance demanded of the chain, the more the need for lubrication.

Lubricate the chain periodically (about once a week) so that the chain always remains damp with oil. Perform drip lubrication or apply lube with a brush. For conveyor chains with grease pockets, grease should typically be supplied every six months.

6.1 Lubrication locations

Since wear between pins and bushes causes chain elongation, lubrication must be maintained on all contact surfaces. Lubricant should be applied to the clearance between the outer plate and the inner plate on the slack side of the chain.

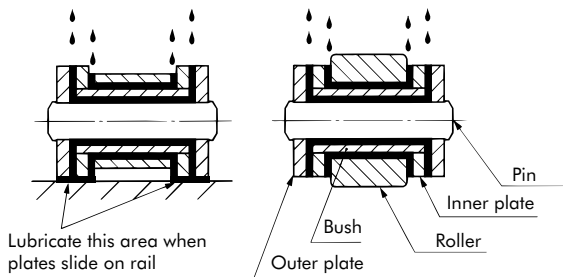

6.2 Recommended Lubrication

Lubricating your chain will reduce the wear of all chain parts as well as reduce required drive.

Generally, lubricate once a week with ISO VG100 - ISO VG150 (SAE30 - 40) oil by drip method or brush.

6.3 TUSBABI Automatic Lubricator

TUSBABI Automatic Lubricator can be used to ensure precise and reliable lubrication. The lubricator is automatically activated by the chain roller pushing the pump's checker arm to release the set amount of lubricant through nozzles. Accordingly, it does not require either electrical or hydraulic supply for the pump.

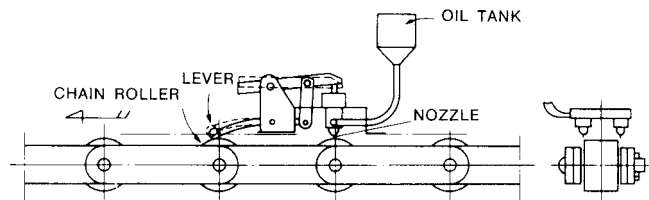

This lubricator, however, cannot be used when the conveyor chain functions as an overhead trolley conveyor or when the chain requires many lubrication points. In these cases, a mist type lubricator operated by compressed air is recommended. For coil conveyor chain, an automatic grease feeder is available.

6.4 When to Avoid Lubrication

In most cases, lubrication is ineffective for bulk conveyors that convey powdery and granular materials. For flow or trough conveyors, the chain buries itself in the material as it moves in the conveying direction. Dust or other particles can become embedded in the chain and reduce or eliminate the lubricant effect of the oil.

Also, when the chain is used in high temperature environments lubrication has to be carefully selected.

7. TENSION ADJUSTMENT

The correct amount of the slack is essential for proper operation of the chain. When the chain is too tight, working parts such as sprocket, shaft, bearing etc., carry a much heavier load. Conversely, too much slack is also harmful and causes the chain to climb the sprocket teeth.

7.1 Frequency of adjustment

The chain has a tendency to stretch a certain amount at the beginning of the operation due to slight distortion of its component parts. After this initial elongation, the chain elongates slightly, but constantly, by normal wear. To maintain proper chain tension, adjustments, if necessary, should be made at regular intervals. Neglect of careful inspection increases the chance of an accident or injury.

Frequency of adjustment:

1 st week	once a day
2 nd - 4 th week	twice a week
Thereafter	twice a month

Note:

The above frequency schedule is based on 8 hours operation a day. When working hours are increased, the frequency of adjustment should be increased accordingly.

7.2 Even adjustment of take-up on both sides

This can be easily achieved when take-ups are cooperating screw type or counterweight type.

Where two parallel chains are adjusted by two independently operated take-ups, care must be taken to ensure even adjustment on both the left and right side. An uneven adjustment will cause the plate and side of sprocket teeth to interfere with each other and result in an overload condition.

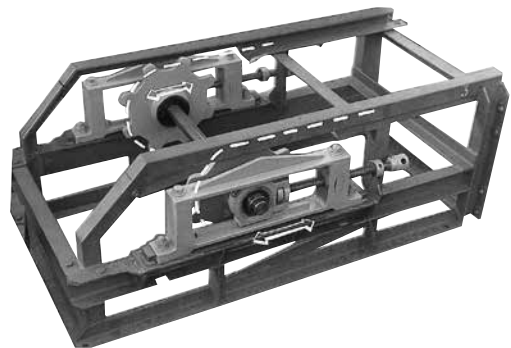

Take-up units

7.3. Insufficient take-up adjustment

If the chain is still too long after complete adjustments of take-up, shorten it by taking off two links.

8. CHAIN TEST RUN

After installing the chain, carry out a test run and check the following items before you actually start running the chain.

8.1 Before beginning Test Run

- 1) Connecting spring clips and cotter pins are installed correctly.
- 2) Chain slack is adjusted properly.
- 3) Lubrication is adequate.
- 4) The chain does not come into contact with casing or covers.

8.2 Test Run

- 1) There are no strange noises.
- 2) There is no excessive chain vibration.
- 3) The chain does not run up on the sprockets.
- 4) The chain is not jammed into the sprockets.
- 5) The rails and sprockets are installed correctly.
- 6) The rollers rotate smoothly.
- 7) There are no stiff areas during chain articulation.

Caution

An unloaded trial run should be conducted after installation by intermittently switching the system on and off several times. After inspection, a continuous unloaded trial run should be conducted. Prior to the trial run, be sure to lubricate the chain to allow lubricant to work into various components.

9. LIFE OF TSUBAKI CONVEYOR CHAIN AND SPROCKET

After a certain period of time, wear will eventually appear on the chain and sprocket. The life of conveyor chain depends on the wear of each component part and on pitch elongation. Careful inspection is required more often than for power transmission roller chain.

TSUBAKI recommends that periodic inspections of the wearing parts are conducted and that care be taken to ensure that proper maintenance is carried out. Also, a schedule for changing the chains should be established. The life of the conveyor chain component parts is shown below.

9.1 Roller Life

1) R roller & F roller (Large roller & Flanged roller)

When wear between rail, bush and roller causes the lower surface of plate to contact the rail, the chain has usually reached the end of its service life. When the plate starts contacting the rail, rolling contact becomes sliding contact between the plate and rail, resulting in greater wear, an increase in chain tension and required horsepower. Such wear generally appears on horizontal or inclined apron conveyors, slat conveyors, etc.

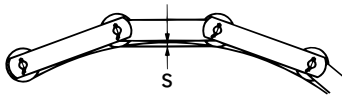

Where a curved section of rail is provided, the amount of allowable wear is decreased by a dimension equivalent to "S". More care must be taken to observe wear than with horizontal sections.

2) S roller (Small roller)

Small type rollers are generally useable until there is a 40 % reduction in wall thickness of rollers due to wear.

9.2 Bush Life

Bushes of rollers are generally useable until 40 % thickness of bushes according to wear.

9.3 Plate Life

Reciprocal friction between inner and outer plates and contact between side surface of roller and inside surface of plate causes such wear as (A) and (B) as follows.

If the amount of wear exceeds 1/3 of the original plate thickness, the tensile strength of the chain will be reduced. When plate wear appears faster than wear of other component parts, misalignment of the conveyor during installation is the likely cause in most cases. Misalignment can also develop during operation of the conveyor. Therefore, careful inspection is required to ensure maximum working life. Please check the following items accordingly.

- Correct alignment of driving and driven sprockets
- Correct alignment of shaft in horizontal and vertical planes
- Preciseness of level gauge and accurate levelling

With TSUBAKI Flow Conveyor chain, the plates move directly on the material to be conveyed or on a steel plate casing. The working life expires when the worn section equals $A/2$ or $H/8$ as follows.

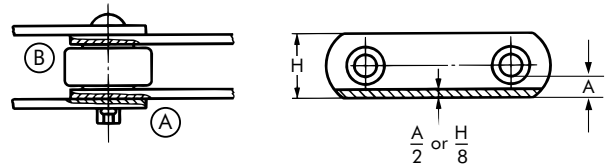

9.4 Chain Pitch Elongation

When the chain engages with the sprocket or runs on curved rail section, the chain flexes causing the chain to stretch. In most cases, this is due to wear of the bearing parts such as the pins and bushes. As chain pitch elongation increases, the chain tends to climb the top of sprocket. This makes smooth operation of the conveyor impossible. The limit of pitch elongation is generally 2 % of the chain pitch.

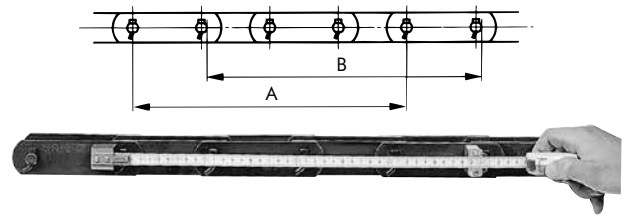

The above indicates the method of measuring chain pitch. Using a steel tape measure, measure as many even number of pitches as possible (at least 4 pitches required). Measuring points should be properly determined according to (A) or (B) in the above, depending on the wear condition of the conveyor chain. The chain pitch elongation per link is to be computed by comparing the actual pitch measured against the original chain pitch.

9.5 Sprocket Life

When the sprocket is worn, the chain tends to cling to the sprockets and vibrate. The amount of allowable wear depends on the conveyor type and chain size, but generally, wear to a depth of 3 to 6 mm is a sign that the existing sprocket should be repaired or replaced with a new one to ensure continued chain life.

The following diagram is a guide in determining sprocket tooth face wear limits.

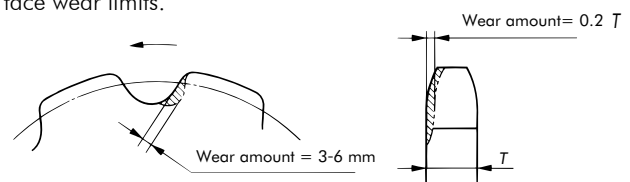

Tooth face wear

Tooth side wear

As per the diagram on the right, wear on the tooth side means that shaft centering is incorrect. Check and adjust.

10. OTHER PRECAUTIONS

10.1 Conveyor Downtime

Always remove load from conveyors before stopping. Starting with load may cause overloading. Inspect chain before starting a conveyor that has been stopped for extended periods.

10.2 Fixing Parts

The nuts of buckets, aprons, slats, and other items that are bolted to the chain can come loose and fall off due to chain vibration during operation. Spot weld them or take other action to ensure they do not loosen.

10.3 Temperature and Freezing

Conveyors may freeze when there is a difference in temperature, such between day and night temperatures in winter. Lubricate chain and inspect often while paying attention to temperature changes when conveying liquid items. Condensation may form when conveying high temperature items in a case conveyor.

10.4 Storing Extra Chain

TSUBAKI recommends having extra chain on hand in the event of chain failure. Store extra chain indoors where there is low humidity. Apply an anti-rust oil when storing for extended periods. It may be convenient to attach a tag to the chain with the chain name, drawing number, date of purchase, equipment name, and other pertinent information.

10.5 Preventative Maintenance of Conveyor





In addition to the above maintenance and inspection, create a conveyor history log and periodically record conveyor capacity, conveyor speed, main shaft rotation speed, current, voltage, power, actual operating time, actual conveyance load, inspection/lubrication days, accidents, etc. This can help prevent unexpected accidents and facilitate repairs.

10.6 Cleaning

Periodically clean chain and rail if in contact with foreign particles or conveyed items.

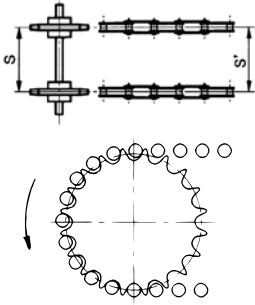
11. CONVEYOR CHAIN TROUBLESHOOTING AND PROBLEM SOLVING

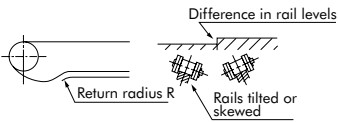
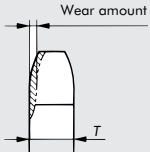
11.1 General

Symptom	Possible Causes	Solution
 <p>Chain rides up on the sprocket</p>	Chain and sprocket do not match.	Replace the chain or sprocket with the correct size.
	Angle of chain wrap on the sprocket is insufficient.	Chain must be engaged with at least three sprocket teeth.
	Excessive load.	Reduce the load, add lubrication, or increase the size of the chain.
	Inadequate back-tension.	Adjust the catenary of take-up idler, or install a tensioner.
	Elongation of the chain due to wear or excessively worn sprocket teeth.	Replace with new chain and sprockets.
	Distance between the center of the chain and the sprocket do not match. $S \neq S^1$	Inspect and correct.
 <p>Chain winds onto the sprocket (Poor separation from the sprocket teeth)</p>	Excessive slack in chain.	Adjust the chain length or the distance between shafts. Or install a tensioner.
	Span between shafts is too large.	Install a guide or an idler.
	Distance between the center of the chain and the sprocket do not match.	Inspect and correct.
	Poor chain articulation due to rust, caused by bad environment, or due to inappropriate lubrication.	Replace the chain. Protect the chain from the environment by appropriate lubrication and/or cover.
	Elongation of the chain due to chain wear or excessively worn sprocket teeth.	Replace with new chain and sprocket.
<p>Unusual noises</p>	Lack of or unsuitable lubrication.	Provide proper lubrication according to the operating conditions.
	Chain casing or bearings are loose.	Tighten all bolts and nuts.
	Interference of casing with the chain or other moving parts.	Inspect and correct.
	Excessively worn chain or sprocket.	Replace with new chain and sprockets.
	 <p>Improper guide rail installation.</p>	Inspect and correct.
 <p>Excessive wear on the inside surface of the link plates and sides of the sprocket teeth</p>	Improper installation	Correct sprocket and shaft installation.
	 <p>Chain is being pushed to the side.</p>	Remove the cause of the push and/or install a guide roller.

11. CONVEYOR CHAIN TROUBLESHOOTING AND PROBLEM SOLVING



Symptom	Possible Causes	Solution
Excessive wear on the outside surface of the link plates and pin heads	Improper installation of guides, etc.	Check the condition of the guides, and increase the gap between the guides and the chain.
Excessive wear of the sprocket teeth valleys and drive sides	Excessively worn chain.	Replace both the chain and the sprocket.
	Insufficient number of teeth.	Increase the number of teeth.
	BF Chain being used (no rollers).	Change to an RF Chain (with rollers).
	Tooth hardness is insufficient with respect to the load and conveyed materials or foreign particles.	Use a sprocket with hardened or changeable teeth.
 Poor articulation	Chain and sprocket do not match.	Replace chain or sprocket.
	Corrosion.	Install a partition to protect the chain. Select a suitable chain.
	Inadequate lubrication.	Provide adequate lubrication.
	Foreign particles stuck in clearance.	Install a partition to protect the chain.
	Chain is not installed correctly.	Inspect installation and correct as necessary.
	Contamination from metal dust or dirt because of improper lubrication.	Remove the chain, wash it thoroughly, and provide proper lubrication.
	High temperatures.	Consult with Tsubaki regarding this situation.
	Excessive load (causing bent pin, or cracked bush)	Reduce the load or increase the size of the chain.
The chain sticks and slips (This can be caused by a combination of many problems; Therefore, the listed remedies may not solve the problem.)	The conveyor speed is too slow.	Increase conveyor speed.
	Insufficient rigidity in the conveyor system.	Increase the frame rigidity; Increase the chain size.
	The force of friction is excessively large.	Lubricate between the guide rail and chain. Or switch to Bearing Roller Chain.
	The conveyor system is too long.	Divide the conveyor system into sections to decrease the length.
	Inconsistent speeds due to movement along a polygonal path.	Use a 12 or more toothed drive sprocket.
Chain is rusting	Inappropriate selection of material.	Select a more suitable chain material.
	Improper lubrication or poor environment.	Replace chain and protect the chain from the environment by appropriate lubrication and/or a cover.
	Condensation	Eliminate the temperature difference between the inside and outside of the conveyor (using insulation, etc.).
Excessive wear caused by the conveyed material	The chain is contaminated with especially abrasive materials such as mineral powders.	Install a partition to protect the chain. Select a suitable chain.
Excessive wear caused by corrosion	The chain is exposed to acidic or alkaline substances.	Use a chemical-resistant material. Use a wear-resistant material for the worn parts.
Excessive wear caused by electro-chemical corrosion	When the chain is covered with water or passes through a solvent causing galvanic corrosion.	Use a chemical-resistant material. Use a wear-resistant material for the worn parts.

11. CONVEYOR CHAIN TROUBLESHOOTING AND PROBLEM SOLVING

11.2 Link Plate Related

Symptom	Possible Causes	Solution
Static Fracture Breakage of link plate.	Excessive large shock load.	Reduce shock loads by making the start-up, stopping, and other actions smoother (install a shock absorber). Increase the size of the chain.
	Excessive wear or corrosion.	Install a partition to protect the chain. Lubricate regularly. Select a suitable chain.
	Spreading of link plates.	Replace with new chain and correct installation.
Fatigue Fracture Breakage of link plate.	Repetitive loads are greater than maximum allowable load.	Reduce the load, increase the size of the chain.
	Repetitive load on attachments are greater than maximum allowable load.	Reduce the load, increase the size of the chain.
Deformation of link plate holes.	Excessive load.	Reduce the load, increase the size of the chain.
	Inadequate lubrication.	Replace with a new chain and improve the lubrication.
	Poor articulation	Use a chain with a larger clearance between pin and bush.
Corrosion stress cracks appear, usually as bow-shaped cracks in the link plate.	The chain is being used in an acidic or alkaline environment.	Install a partition to protect the chain. Select a suitable chain. (Please consult Tsubaki.)

11.3 Pin Related

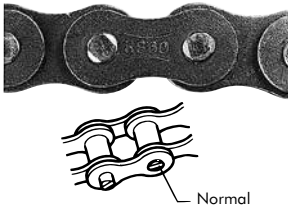
 <p>Static fracture The type of fracture found when subjecting the chain to the breakage test. Occurs when the chain is subjected to a load greater than its breakage strength.</p>	 <p>Fatigue fracture Occurs when the pin is repetitively subjected to loads greater than its fatigue limit. Recheck the size of the peak load and formulate a countermeasure.</p>	 <p>Shock-induced bending fracture The pin is subjected to a large shock load and breaks. The side with the initiating point receives tensile load and the fracture progresses from this point. The pin is especially susceptible to becoming weak with regard to bending when the surface of the pin has corroded. This type of phenomenon occurs quite easily.</p>
<p>Symptom</p> <p>Breakage of pin.</p> <p>Pin rotates or begins to stick out.</p>  <p>Symptom</p> <p>Wear or rust occurs only at the connecting pin.</p>	<p>Possible Causes</p> <p>Excessive large shock load.</p> <p>Loads are greater than maximum allowable load.</p> <p>Corrosion.</p> <p>Excessive load.</p> <p>Operating a chain with high load without proper lubrication can create friction between the pin and bush, causing the pin to rotate.</p> <p>Possible Causes</p> <p>Improper initial lubrication at installation.</p>	<p>Solution</p> <p>Reduce shock loads by making the start-up, stopping, and other actions smoother (install a shock absorber). Increase the size of the chain.</p> <p>Reduce the load, increase size of the chain.</p> <p>Install a partition to protect the chain. Select a suitable chain.</p> <p>Replace chain immediately. Reduce the load, increase the size of the chain.</p> <p>Replace chain immediately. Provide proper lubrication according to the operating conditions.</p> <p>Replace the connecting link. Provide proper lubrication.</p>

11. CONVEYOR CHAIN TROUBLE SHOOTING AND PROBLEM SOLVING

11.4 Bush / Roller Related

Symptom	Possible Causes	Solution
Improper roller rotation and uneven roller wear	Excessive load on the rollers.	Reduce excessive loads. Provide sufficient lubrication. Increase the size of the chain. Consider bearing roller chain.
	Particles of conveyed material, or other foreign particles stuck between the bush and roller.	Periodically clean the chain. Install a partition to protect the chain.
	Particles of conveyed material, or other foreign particles have built up on the rail.	Clean regularly, and install a partition to protect the chain/rail.
	Lubricant is falling on the roller surface and rail without entering between the bush and roller or between roller and link plate.	Select an appropriate lubricant and lubrication method.
	Rust on the bush and/or rollers.	Select a more suitable chain material.
	The inner link plate is forced inwards.	Re-inspect the installation and load conditions.
	Bush is cracked.	Re-inspect the installation and load conditions.
	The side surface of the roller is contacting the side of the link plate due to a thrust load.	Eliminate the cause of the thrust load.
	Chain and sprocket do not match.	Replace the chain or sprocket with the correct size.
	Sprocket teeth are excessively worn.	Use a sprocket with hardened or changeable teeth.
Roller is opening up.	Excessive load. 	Reduce the load. Provide adequate lubrication.
Roller and/or bush splits in two pieces.	Excessive load.	Reduce the load, increase the number of chain strands or the size of the chain.
	Inadequate lubrication.	Provide adequate lubrication.
	Too few teeth with respect to conveyor speed.	Increase the number of teeth or decrease the speed.
Roller is becoming hourglass shaped.	Excessive load or inadequate lubrication.	Replace with new chain. Improve the lubrication or loading conditions.
	Excessively worn rail.	Replace the rail.

APPENDIX

Chain Cutting Tools

Your purchased chain is either a unit length or a reel. The following tools are available for cutting the chain to a desired length.

1. Chain Vice

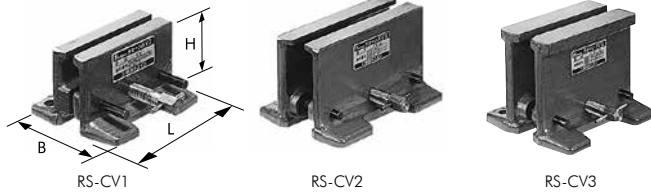

Model Number	Applicable Chain									Dimensions		
	Single-strand			Double-strand			Triple-strand			L	H	B
RS-CV1	RS40-RS80	RS08B-RS16B	1/2" - 1"	RS40	RS08B	1/2"	-	-	-	100	65	94-115
RS-CV2	RS40-RS160	RS08B-RS32B	1/2" - 2"	RS40-RS100	RS08B-RS20B	1/2" - 1 1/4"	RS40-RS100	RS08B-RS20B	1/2" - 1 1/4"	180	110	120-151
RS-CV3	RS80-RS240	RS16B-RS48B	1" - 3"	RS80-RS160	RS16B-RS32B	1" - 2"	RS80-RS100	RS16B-RS20B	1" - 1 1/4"	200	170	180-220

2. Punch



Primary Punch	Model Number			Applicable Chain		
	L	Secondary Punch	L			
RS-P14	60	RS-P24	80	RS40-RS60	RS08B-RS12B	1/2" - 3/4"
RS-P15	70	RS-P25	90	RS80-RS120	RS16B-RS24B	1" - 1 1/2"
RS-P16	80	RS-P26	120	RS140-RS240	RS28B-RS48B	1 3/4" - 3"

Rivet Punch	L	Applicable Chain		
		Model Number	Model Number	Model Number
RS-RP01	100	RS40	RS08B	1/2"
RS-RP02	100	RS50	RS10B	5/8"
RS-RP03	100	RS60	RS12B	3/4"
RS-RP04	100	RS80	RS16B	1"

3. Chain Breakers

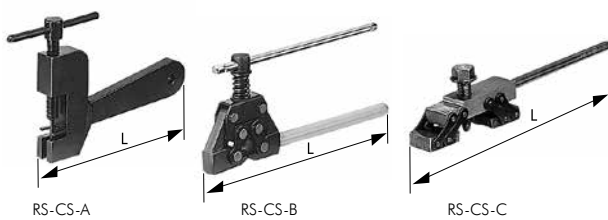

Model Number	L	Applicable Chain (Single Strand & Double Strand)	
RS-CS-A1	116	RS25	1/4"
RS-CS-A2	119	RS35	3/8"
RS-CS-A3	119	RS41	1/2"
RS-CS-A4	119	-	RF06B 3/8"
RS-CS-B1	185	RS40-RS60	RS08B-RS12B 1/2" - 3/4"
RS-CS-C1	222	RS80-RS100	RS16B-RS20B 1" - 1 1/4"
RS-CS-C2	290	RS120-RS140	RS24B-RS28B 1 1/2" - 1 3/4"
RS-CS-C3	708	RS160-RS240	RS32B-RS48B 2" - 3"

Chain Connecting Tool

1. Chain Puller

This tool pulls the two ends of the chain together when installing the chain on a machine.

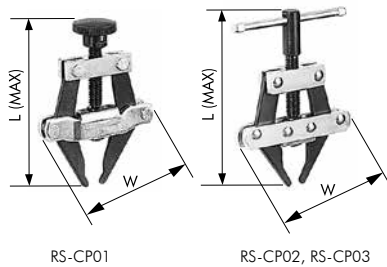

Model Number	L	W	Applicable Chain (Single-Strand)		
RS-CP01	118	70	RS35-RS60	RF06B-RS12B	3/8" - 3/4"
RS-CP02	185	112	RS60-RS100	RS12B-RS20B	3/4" - 1 1/4"
RS-CP03	250	145	RS80-RS240	RS16B-RS48B	1" - 3"

Chain Elongation Scale

The Chain Elongation Scale allows for a quick check to determine whether an ANSI or DIN/BS Roller Chain has reached its elongation limit and should be replaced.

Applicable chain sizes

ANSI Roller Chains RS40 to RS240
 DIN/BS Roller Chains RS08B to RS40B

Measurement procedure

1. Select a straight section of the chain that regularly engages with the sprocket. Align the Chain Elongation Scale with a pin.



2. Check where along the scale the pin of the reference pitch is positioned. (reference pitch is indicated in the table on the scale)

Scale positioning on a new product

Wear elongation limit

If the indicating arrow on the scale is beyond the center of the reference pin, the chain has reached its elongation limit and should be replaced.

Precautions

- This Chain Elongation Scale cannot be used to determine the elongation limit of attachment chain or leaf chain.
- Check chain elongation at the location on the chain where the sprocket teeth engage the most.
- Check chain elongation at a location on the chain where tensile force is applied.
- Do not use the scale for any purpose other than measuring chain elongation.
- Always abide by industrial safety regulations and follow maintenance instructions provided by equipment manufacturer.

CORROSION RESISTANCE GUIDE

☆☆ Highly corrosion resistant
 ☆ Partially corrosion resistant
 ✕ Not corrosion resistant
 - Not tested

Substance	Concentration	Temp. °C	SS	AS	NS	TI	PC/P	PC-SY
Acetic Acid	10%	20	☆☆	☆☆	☆☆	☆☆	☆☆	☆☆
Acetone		20	☆☆	☆☆	☆☆	☆☆	☆☆	✕
Alcohol			☆☆	☆☆	☆☆	☆☆	☆☆	☆☆
Aluminum Sulfate	Saturated	20	☆☆	✕	☆☆	☆☆	-	-
Ammonia Water		20	☆☆	☆☆	☆☆	☆☆	☆☆	☆☆
Ammonium Chloride	50%	Boiling point	☆	✕	☆☆	☆☆	-	-
Ammonium Nitrate	Saturated	Boiling point	☆☆	☆☆	☆☆	☆☆	☆	☆☆
Ammonium Sulfate	Saturated	20	☆☆	☆	☆☆	☆☆	-	-
Beer		20	☆☆	☆☆	☆☆	☆☆	☆☆	☆☆
Benzene		20	☆☆	☆☆	☆☆	☆☆	☆☆	☆☆
Boric Acid	50%	100	☆☆	☆☆	☆☆	☆☆	-	-
Butyric Acid		20	☆☆	☆☆	☆☆	☆☆	☆☆	-
Calcium Chloride	Saturated	20	☆	✕	☆☆	☆☆	☆	☆☆
Calcium Hydroxide	20%	Boiling point	☆☆	☆☆	☆☆	☆☆	☆☆	☆☆
Calcium Hypochlorite	11-14%	20	☆☆	✕	☆☆	☆☆	✕	☆☆
Carbonated water			☆☆	☆☆	☆☆	☆☆	-	-
Carbon Tetrachloride (dry)		20	☆☆	☆☆	☆☆	☆☆	☆☆	☆☆
Chlorinated Water			✕	✕	☆☆	☆☆	✕	-
Chlorine Gas (dry)		20	☆	✕	☆	☆☆	-	☆☆
Chlorine Gas (moist)		20	✕	✕	☆	☆☆	-	☆☆
Chromic Acid	5%	20	☆☆	☆	☆☆	☆☆	✕	☆☆
Citric Acid	50%	20	☆☆	☆☆	☆☆	☆☆	-	☆☆
Coffee		Boiling point	☆☆	☆☆	☆☆	☆☆	☆☆	☆☆
Creosote		20	☆☆	☆☆	☆☆	☆☆	-	-
Developing Solution		20	☆☆	☆	☆☆	☆☆	☆☆	☆☆
Ethyl Ether		20	☆☆	☆☆	☆☆	☆☆	☆☆	☆☆
Ferric Chloride	5%	20	☆	✕	☆	☆☆	-	-
Formalin	40%	20	☆☆	☆☆	☆☆	☆☆	-	-
Formic Acid	50%	20	☆☆	☆☆	☆☆	☆☆	✕	☆☆
Fruit Juice		20	☆☆	☆	☆☆	☆☆	☆☆	☆☆
Gasoline		20	☆☆	☆☆	☆☆	☆☆	☆☆	☆☆
Glycerol		20	☆☆	☆☆	☆☆	☆☆	☆☆	☆☆
Honey			☆☆	☆☆	☆☆	☆☆	☆☆	☆☆
Hydrochloric Acid	2%	20	✕	✕	✕	☆☆	✕	☆☆
Hydrogen Peroxide	30%	20	☆☆	☆	☆☆	☆☆	✕	☆☆
Hydrogen Sulfide (dry)			☆☆	☆☆	☆☆	☆☆	☆☆	☆☆
Hydrogen Sulfide (moist)			✕	✕	✕	☆☆	✕	-
Hydroxybenzene		20	☆☆	☆☆	☆☆	☆☆	✕	☆☆
Kerosene		20	☆☆	☆☆	☆☆	☆☆	-	☆☆
Ketchup		20	☆☆	☆☆	☆☆	☆☆	☆☆	☆☆
Lactic Acid	10%	20	☆☆	☆	☆☆	☆☆	☆☆	-
Lard			☆☆	☆☆	☆☆	☆☆	-	-
Linseed Oil	100%	20	☆☆	☆	☆☆	☆☆	☆☆	-
Malic Acid	50%	50	☆☆	☆☆	☆☆	☆☆	☆☆	☆☆
Mayonnaise		20	☆☆	☆	☆☆	☆☆	☆☆	☆☆
Milk		20	☆☆	☆☆	☆☆	☆☆	☆☆	☆☆

Key: AS: 600 AS Series PC: Poly-Steel Chain
 SS: 304 SS Series

CORROSION RESISTANCE GUIDE

Substance	Concentration	Temp. °C	SS	AS	NS	TI	PC/P	PC-SY
Nitric Acid	5%	20	☆☆	☆	☆☆	☆☆	✗	☆☆
Nitric Acid	65%	20	☆☆	✗	☆☆	☆☆	✗	☆☆
Nitric Acid	65%	Boiling point	☆	✗	☆	☆☆	✗	✗
Oil (Plant, Mineral)		20	☆☆	☆☆	☆☆	☆☆	☆☆	☆☆
Oleic Acid		20	☆☆	☆☆	☆☆	☆☆	☆☆	-
Oxalic Acid	10%	20	☆☆	☆	☆☆	☆☆	-	☆☆
Paraffin		20	☆☆	☆☆	☆☆	☆☆	☆☆	☆☆
Petroleum		20	☆☆	☆☆	☆☆	☆☆	☆☆	-
Phosphoric Acid	5%	20	☆☆	☆	☆☆	☆☆	✗	☆☆
Phosphoric Acid	10%	20	☆	☆	☆	☆☆	✗	☆☆
Picric Acid	Saturated	20	☆☆	☆☆	☆☆	☆☆	-	-
Potassium Bichromate	10%	20	☆☆	☆☆	☆☆	☆☆	☆☆	-
Potassium Chloride	Saturated	20	☆☆	☆	☆☆	☆☆	-	-
Potassium Hydroxide	20%	20	☆☆	☆☆	☆☆	☆☆	☆☆	☆☆
Potassium Nitrate	25%	20	☆☆	☆☆	☆☆	☆☆	☆☆	-
Potassium Nitrate	25%	Boiling point	☆☆	✗	☆☆	☆☆	-	-
Potassium Permanganate	Saturated	20	☆☆	☆☆	☆☆	☆☆	-	☆☆
Sea-Water		20	☆	✗	☆☆	☆☆	☆	☆☆
Soap-and-Water-Solution		20	☆☆	☆☆	☆☆	☆☆	☆☆	☆☆
Sodium Carbonate	Saturated	Boiling point	☆☆	☆☆	☆☆	☆☆	-	☆☆
Sodium Chloride	5%	20	☆☆	☆	☆☆	☆☆	☆☆	☆☆
Sodium Cyanide		20	☆☆	-	☆☆	☆☆	-	-
Sodium Hydrocarbonate		20	☆☆	☆☆	☆☆	☆☆	☆☆	-
Sodium Hydroxide	25%	20	☆☆	☆☆	☆☆	☆☆	☆☆	☆☆
Sodium Hypochlorite	10%	20	✗	✗	☆☆	☆☆	✗	☆☆
Sodium Perchlorate	10%	Boiling point	☆☆	✗	☆☆	☆☆	-	-
Sodium Sulfate	Saturated	20	☆☆	☆☆	☆☆	☆☆	-	-
Sodium Thiosulfate	25%	Boiling point	☆☆	☆☆	☆☆	☆☆	-	-
Soft Drink		20	☆☆	☆☆	☆☆	☆☆	☆☆	☆☆
Stearic Acid	100%	Boiling point	✗	✗	☆☆	☆☆	✗	-
Sugar Solution		20	☆☆	☆☆	☆☆	☆☆	☆☆	☆☆
Sulfuric Acid	5%	20	✗	✗	☆☆	☆☆	✗	☆☆
Sulfur Dioxide (moist)		20	☆☆	✗	☆☆	☆☆	-	-
Synthetic Detergent			☆☆	☆☆	☆☆	☆☆	☆☆	☆☆
Syrup			☆☆	☆☆	☆☆	☆☆	☆☆	☆☆
Tartaric Acid	10%	20	☆☆	☆☆	☆☆	☆☆	☆☆	☆☆
Turpentine		35	☆☆	☆☆	☆☆	☆☆	-	-
Varnish			☆☆	☆☆	☆☆	☆☆	-	-
Vegetable Juice		20	☆☆	☆☆	☆☆	☆☆	☆☆	☆☆
Vinegar		20	☆☆	☆☆	☆☆	☆☆	☆☆	☆☆
Water			☆☆	☆☆	☆☆	☆☆	☆☆	☆☆
Whiskey		20	☆☆	☆☆	☆☆	☆☆	☆☆	☆☆
Wine		20	☆☆	☆☆	☆☆	☆☆	☆☆	☆☆
Zinc Chloride	50%	20	☆	✗	☆	☆☆	☆	☆☆
Zinc Sulfate	Saturated	20	☆☆	☆☆	☆☆	☆☆	-	☆☆

☆

GENERAL TERMS AND CONDITIONS OF SALE TSUBAKIMOTO EUROPE B.V.

- 1. General**

In these general terms and conditions 'Tsubaki' shall mean Tsubakimoto Europe B.V.
- 2. Applicability**
 - 2.1 The applicability of the general terms and conditions used by the customer is hereby expressly excluded.
 - 2.2 These general terms and conditions are applicable to all legal relationships in which Tsubaki acts as a seller and/or supplier or as a potential seller and/or supplier of products and/or services.
 - 2.3 Deviations from the provisions in these general terms and conditions shall be permitted only in writing. No rights in relation to agreements that are concluded later may be derived from such deviations.
- 3. Conclusion of the agreement / Measurements & Weight**
 - 3.1 If the customer issues an order, the agreement shall have been concluded if Tsubaki accepts the order in writing or electronically or makes a start with its implementation.
 - 3.2 Drawings, measurements and weights that are shown or provided on the website of Tsubaki or otherwise, shall only be used as indications. The product and/or service to be provided under the agreement need not correspond with the drawing, measurement and weight.
- 4. Prices / Delivery conditions**
 - 4.1 Prices are exclusive of VAT.
 - 4.2 Prices are ex warehouse, unless otherwise agreed in writing.
 - 4.3 Prices are as per Tsubaki described standard unit or packaging only.
 - 4.4 In addition to the price, the customer shall fully pay, unless otherwise agreed in writing, any and all, local taxes, duties, excises, licence fees and other charges levied, assessed or imposed upon Tsubaki due to the manufacture, sale, purchase, export or delivery of the products.
 - 4.5 The customer shall also pay the cost by which such manufacture is increased by reason of any law, ordinance or regulation adopted or promulgated by any government or governmental subdivision, department or agency, or other source, after the date hereof, but prior to the completion and delivery hereunder.
 - 4.6 Changes in labour costs, cost prices of raw materials or materials and/or exchange rate movements related to the performance agreed on, shall entitle Tsubaki to pass on these costs to the customer.
- 5. Delivery/delivery times**
 - 5.1 The delivery period indicated by Tsubaki starts as from the moment that all data, drawings and the like necessary for the performance of the agreement have been received by Tsubaki in its entirety.
 - 5.2 Delivery times agreed with Tsubaki are indicative and shall not constitute deadlines.
 - 5.3 Failure to deliver within the indicated delivery period does not entitle the customer to additional or substitute damages, nor to the customer's non-fulfilment, withholding or postponement of any of its own obligations arising from the agreement.
 - 5.4 If the customer requests Tsubaki to make changes in the performance of the agreement (including, but not limited to, changes in the design or construction of products), or otherwise delay or interrupt the progress of the work under the agreement, the customer shall fully reimburse Tsubaki for any and all additional expenses arising there from.
 - 5.5 Tsubaki shall be entitled to perform its due obligation(s) in stages or in parts. Each partial delivery shall be deemed an independent delivery with respect to the applicability of these general terms and conditions.
- 6. Returned products**
 - 6.1 No products shall be acceptable for return without prior written consent of Tsubaki.
 - 6.2 Special or made-to-order products are not returnable.
 - 6.3 The customer shall prepay freight on all returns, and each return is subject to inspection and acceptance by Tsubaki to assure that the products are in a "re-sellable" condition.
 - 6.4 The customer shall pay a maximum of 10% (ten percent) of the price for handling and restocking costs charge with regard to all authorized returns.
- 7. Payment**
 - 7.1 Payment of Tsubaki's invoices shall ultimately take place within 30 (thirty) days after the invoice date in the manner described by Tsubaki, provided however that Tsubaki may at all times request for payment in advance. Payment shall take place effectively in the currency agreed on and without deduction, set-of, discount and/or deferment.
 - 7.2 In case of overdue payment, all payment obligations of the customer, regardless of whether Tsubaki has already issued an invoice in the matter and of whether Tsubaki has duly performed its obligations, shall be immediately due and payable and the customer shall owe an interest of 1.5% (one and a half percent) per month or per part of a month on the amount due.
 - 7.3 Extra-judicial collection costs shall be charged to the customer in accordance with the collection rates of the Netherlands Bar Association.
 - 7.4 Payment by or on behalf of the customer shall extend to payment of the following charges incurred, in the following order: extra-judicial collection costs, the legal costs, the interest due, and after that the unpaid capital sums according to the order of receipt, regardless of other instructions of the customer.
 - 7.5 The customer can only object to the invoice within the term of payment.
- 8. Intellectual Property Rights and know-how**
 - 8.1 All documentation, sales leaflets, pictures, drawings etc., provided by Tsubaki to the customer, shall at all times remain the exclusive property of Tsubaki.
 - 8.2 The customer shall not be entitled to use the documents referred to in paragraph 1 for any purpose other than for the use of the products to which they relate.
 - 8.3 The customer shall not be entitled to use the documents referred to in paragraph 1 or to duplicate and/or make public to third parties data included therein or in any other way made known to the customer without express prior written consent of Tsubaki.
- 8.4 In the event of any violation of what has been stipulated under paragraph 2 and/or 3, the customer shall pay Tsubaki an immediately payable fine of EUR 10,000 (ten thousand euros) for each violation, regardless of any other of Tsubaki's rights to performance, dissolution, compensation, etc.
- 9. Retention of title**
 - 9.1 All products that are delivered or are to be delivered by Tsubaki remain the property of Tsubaki until Tsubaki is fully paid with regard to:
 - A. all performances due by the customer for all products that are delivered or are to be delivered in accordance with the agreement, and;
 - B. all claims that are the result of the customer's failing in the performance of such agreement(s); the customer shall not be allowed to claim its right of retention concerning costs of custody and to deduct these costs with the performances required by the customer.
 - 9.2 If the customer creates a new product from or partly from products referred to in paragraph 1, this product belongs to Tsubaki and the customer shall consider Tsubaki its owner, until the customer has fully performed all of its obligations referred to in paragraph 1.
 - 9.3 If any product belongs to Tsubaki in accordance with paragraph 1 and/or 2, the customer can have exclusive possession of this product or product within the framework of its normal business operations.
 - 9.4 If the customer is in default in the performance of its obligations referred to in paragraph 1, Tsubaki shall be entitled to recover all the products from their location, at the expense of the customer. The customer hereby irrevocably grants authority to Tsubaki to enter the area used by or for the customer.
- 10. Security**
 - 10.1 If there are valid grounds to expect that the customer shall not perform its obligations, the customer shall be obliged, at the first request of Tsubaki, to immediately furnish adequate security in the form requested by Tsubaki (including complete payment in cash before or on delivery) without prejudice to customer's obligations under the agreement. If and to the extent that the customer has not fully performed its obligations, Tsubaki shall be entitled to suspend performance of its obligations.
 - 10.2 If the customer takes no action on the request referred to in paragraph 1 within 14 (fourteen) days after having received a written warning to that effect, all its obligations shall be immediately due and payable.
- 11. Guarantee**
 - 11.1 With regard to the assembly carried out by Tsubaki, the following guarantee is provided: For 6 (six) months, Tsubaki shall repair faults in the assembly, free of charge, at the discretion of Tsubaki.
 - 11.2 If and to the extent Tsubaki can claim guarantee with respect to its own suppliers, Tsubaki shall provide the following guarantee on products obtained from them: For 6 (six) months, Tsubaki shall supply alternative products, free of charge, if the products supplied exhibit manufacturing defects or defects in the material, at the discretion of Tsubaki.
 - 11.3 The customer can only make a non-recurring claim under the guarantee mentioned in paragraphs 1 and 2 if the customer has performed all its obligations towards Tsubaki.
 - 11.4 Defects which are the result of normal wear, improper use or improper or incorrect maintenance or which occur after changes or repair carried out by or on behalf of the customer, shall not be part of the guarantee.
 - 11.5 Minor differences, which means 10% (ten percent) or less with regard to amounts, measures, weights, numbers and other such data provided, are not considered defects.
- 12. Complaints / obligation to examine / limitation period**
 - 12.1 On delivery, the customer has the obligation to examine whether the products are in conformity with the agreement. If this is not the case, the customer cannot make a claim regarding non-conformity if the customer does not notify Tsubaki in writing in a well-founded manner as soon as possible, but in any event within 8 (eight) days after delivery or after detection of non-conformity was reasonably possible.
 - 12.2 Any and all of the customer's claims and defences based on facts that support the view that the product delivered is not in conformity with the agreement, shall expire 6 (six) months after delivery.
- 13. Dissolution and release**
 - 13.1 If the customer does not perform or incorrectly performs any of its obligations arising from the agreement (such as overdue payment), if the customer is placed under guardianship, involuntary liquidation, suspension of payment or closure or winding up of its company, and also in the case of prejudgment or executory attachment against the customer or if an offer or agreement with regard to an extra-judicial debt settlement with the customer has been made, Tsubaki shall be entitled, at its option, without any obligation for compensation and without prejudice to its other rights, to dissolve the agreement in whole or in part, or to suspend the further execution of the agreement. In these cases, Tsubaki shall be also entitled to claim immediate compensation of the amount due.
 - 13.2 If the proper performance by Tsubaki is partially or completely impossible, whether temporarily or permanently, due to one or more circumstances which cannot be held accountable to Tsubaki, including the circumstances mentioned in the paragraph 14.6, Tsubaki, at its option, shall be entitled to suspend its performance or to dissolve the agreement.
 - 13.3 If the customer is not willing to cooperate with the delivery after Tsubaki has given the customer 14 (fourteen) days to do so, Tsubaki will be released from its obligations, without prejudice to the obligations of the customer.
- 14. Compensation**
 - 14.1 Tsubaki shall only be liable for damages suffered by the customer which can be attributed to gross negligence or intention by Tsubaki to the amount that Tsubaki is insured in accordance with an insurance commonly used in this line of industry and which is actually paid out with respect thereto. The aggregate compensation payable by Tsubaki shall not exceed EUR 500.000 (five hundred thousand euros) per event, whereby a series of related events shall be considered as one event.

GENERAL TERMS AND CONDITIONS OF SALE TSUBAKIMOTO EUROPE B.V.

- 14.2 Tsubaki shall never be liable to pay any compensation other than personal injury or property damage.
- 14.3 Tsubaki shall never be liable for loss of income, profit or revenue, loss due to shutdown or delay in business activities, production losses, loss of operating hours and/or wages paid in vain, extra costs incurred due to external purchasing, loss due to restoration of lost information, missed savings or agreements, discounts or penalties.
- 14.4 Tsubaki stipulates all legal and contractual defences, which it can invoke to fend off its own liability towards the customer, also on behalf of its employees and non-employees for whose acts it is liable in accordance with the law.
- 14.5 Tsubaki shall not be liable with regard to products supplied by Tsubaki which originate from third parties if and to the extent that the applicable third party has excluded its liability.
- 14.6 Under no circumstance shall Tsubaki be held liable for the following circumstances: actions, except gross negligence or intention, of persons used by Tsubaki for the realisation of the agreement; unsuitability of products which Tsubaki uses for the realisation of the agreement; exercising one or more rights by a third party vis-à-vis the customer in the case of a failure in the performance by the customer of an agreement between the customer and the third party concerning products supplied by Tsubaki; industrial action, lock-out of workers, illness, bans on import, export and/or transport, problems with transport, failure to comply with the obligations by suppliers, production failure, natural and/or nuclear disasters, and war and/or threat of war.
- 14.7 The customer shall indemnify Tsubaki against all claims from any third party, in whatever form, with regard to damage and/or loss, which any third party may have suffered due to products of Tsubaki.
- 14.8 Everything stipulated in this article shall be without prejudice to Tsubaki's liability pursuant to mandatory provisions of law.
- 15. Amendment of general terms and conditions**
- 15.1 Tsubaki has the right to amend these general terms and conditions from time to time. Amendments apply also with regard to agreements already concluded. Amendments shall be notified in advance in writing or electronically to the customer and shall enter into effect 30 (thirty) days after this notification or on such date as specified in the notification.
- 15.2 In the event the customer fails, with respect to the amended general terms and conditions, to give written notice that it does not accept these amended general terms and conditions

prior to the day on which the aforementioned terms enter into effect, such as is indicated here above, the customer shall be deemed to have accepted these amended general terms and conditions.

16. Conversion

If and to the extent that any provision in these general terms and conditions cannot be invoked on grounds of reasonableness and fairness or its unreasonably onerous nature, the provision shall be given a meaning that corresponds as much as possible to its content and purpose, making it thereby possible to invoke this provision.

17. Assignment

- 17.1 Tsubaki is entitled to assign one or more of its obligations or its entire legal relationship with the customer to a third party without consent of the customer. Tsubaki shall inform the customer of this transfer in writing.
- 17.2 The customer is only entitled to assign one or more of its obligations or its entire legal relationship with Tsubaki to a third party upon Tsubaki's express prior written consent.

18. Applicable law / competent court

- 18.1 All legal relationships between Tsubaki and the customer shall be governed by the laws of the Netherlands, without taking into account the principles of conflict of laws.
- 18.2 The applicability of the United Nations Convention on Contracts for the International Sale of Goods is expressly excluded.
- 18.3 All disputes which may arise between Tsubaki and the customer that fall under the jurisdiction of a district court, shall only be submitted to the court in the judicial district in which Tsubaki has its registered office, unless Tsubaki as a plaintiff or an applicant opts for the competent court in which the customer has its registered office or address for service.

19. Dutch text prevails

If and insofar as there is a discrepancy between the general terms and conditions in the Dutch language and those in the English language, those in the Dutch language shall prevail.

These conditions were filed at the Chamber of Commerce and Industry in Rotterdam.

For Safe Use



WARNING Obey the following points in order to prevent hazardous situations.

- Do not use chains and accessories (accessories and parts) for anything other than their original purpose.
- Never perform additional processing on the chain:
 - Do not anneal the various parts of the chain.
 - Do not clean the chain with either acid or alkali, as they may cause cracking.
 - Do not electroplate the chain or its parts, as they may cause cracking due to hydrogen embrittlement.
 - Do not weld the chain, as the heat may cause cracking or a reduction in strength.
 - When heating or cutting the chain with a torch, remove the links immediately adjacent and do not use them again.
- When there is need to replace a lost or damaged portion of a chain, always replace the whole chain with a new product rather than replacing only the lost or damaged portion.
- When using a chain on suspension equipment, establish a safety manual, etc., and strictly prevent entry to the area directly below the suspended object.
- Always employ hazard protector devices for the chain and sprocket (safety cover, etc.).
- If a substance that can cause embrittlement cracking (acid, strong alkali, battery fluid, etc.) adheres to the chain, stop using the chain immediately and replace it with a new one.
- During installation, removal, maintenance inspection and lubrication of the chain:
 - Perform the operation according to the instruction manual or this catalog.
 - Always turn off the power switch to the device and make sure that it cannot be turned on accidentally.
 - Anchor the chain and parts so that they cannot move freely.
 - Perform cutting and connecting procedures properly using a press or other special tool.
 - Wear clothing and employ protective devices that are appropriate to the job (safety glasses, gloves, safety shoes, etc.).
 - Only allow experienced personnel to perform chain replacement procedures.
- In order to prevent hazards, damage, or injury when cutting a Leaf Chain, always install hazard protection devices (safety device, etc.) on the suspension equipment employing the Leaf Chain.



CAUTION Obey the following points in order to prevent accident.

- Only handle the chain after thoroughly understanding its structure and specifications.
- When installing a chain, inspect it in advance to confirm that it has not been damaged in transport.
- Be sure to perform regular maintenance inspections on the chain and sprocket.
- Chain strength varies according to manufacturer. When selecting a chain based on a Tsubaki catalog, always use the corresponding Tsubaki product.
- Minimum tensile strength refers to the failure point when the corresponding load is applied to the chain once and does not refer to the allowable operational load.

DISTRIBUTED BY:

H. FRÖHLICH AG^{TEC}

*H. FRÖHLICH AG · Industrietechnik
Widenholzstrasse 1 · CH-8304 Wallisellen
Tel. +41 44 910 16 22 · Fax +41 44 910 63 44
info@h-froehlich-ag.ch · www.h-froehlich-ag.ch*

TEU CatM-15

NOTE: in accordance with the policy of Tsubakimoto Europe B.V. to consistently improve its products, the specifications in this catalogue are subject to change without notice.

Copyright © 2015 Tsubakimoto Europe B.V.

The contents of this catalogue must not be reproduced in any way unless written permission is obtained.

Every care has been taken to ensure the accuracy of the information in this catalogue but no responsibility or liability can be accepted for any loss or damage suffered as a result of information it contains.

The catalogue information is subject to change without notice so please do not hesitate to contact Tsubakimoto Europe if you need clarification or have any queries.

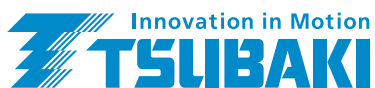

Tsubakimoto Europe B.V.

Aventurijn 1200
3316 LB Dordrecht
The Netherlands

Phone: +31 (0)78 620 4000
Fax: +31 (0)78 620 4001
E-mail: info@tsubaki.eu
Internet: tsubaki.eu

Tsubaki Deutschland GmbH

ASTO Park Oberpaffenhofen
Friedrichshafener Straße 1
D-82205 Gilching, Germany

Phone: +49 (0)8105 7307 100
Fax: +49 (0)8105 7307 101
E-mail: antriebstechnik@tsubaki.de
Internet: tsubaki.de

Tsubakimoto UK Ltd.

Osier Drive, Sherwood Park
Annesley, Nottingham NG15 0DX
United Kingdom

Phone: +44 (0)1623 68 87 00
Fax: +44 (0)1623 68 87 89
E-mail: sales@tsubaki.co.uk
Internet: tsubaki.eu